

DESIGN AND EXPERIMENTAL VERIFICATION OF MOTION CONTROL ROBOTIC ARM AND ITS INDUSTRIAL APPLICATIONS

Mr.Dilip Singh J
Department of
Mechanical
Engineering
Jeppiaar
EngineeringColle
ge
Chennai

Sai Aswin A J
Department of
Mechanical
Engineering
Jeppiaar
Engineering
College
Chennai

Aadhavan S
Department of
Mechanical
Engineering
Jeppiaar
Engineering
College
Chennai

Akash V S
Department of
Mechanical
Engineering
Jeppiaar
Engineering
College
Chennai

Arun Kumar R
Department of
Mechanical
Engineering
Jeppiaar
Engineering
College
Chennai

ABSTRACT

1. INTRODUCTION

The robotic arm is used for multiple industrial applications, from welding, material handling, and thermal spraying, to painting and drilling. The robotic technology also provides human-like dexterity in a variety of environments. Robotic arms and other robotic instruments may sound like a futuristic development, but they have been around for years, helping out surgeons and engineers alike. Less common, though, are prosthetic, robotic arms that allow people who have lost a limb to regain freedom of movement. Our Project serves the humanity because there are people around us who have lost their hand or arms due to accident or warfares.

These machines, which are operated with the need for human assistance in advance, have been made to operate spontaneously without the need of human power with the progress of technology. One of the most used components of automation systems is robots. Robotic arms had been mostly used for industry automation and operation in the hazardous environment. Many robotic controls are very expensive, due to high-precision actuators and custom machining of components. There are number of dimensions on which robotic arms can be evaluated, such as backlash, payload, speed, repeatability, compliance, human safety, and cost. In robotics research, some of these dimensions are more important than others: for grasping and object manipulation, high repeatability and low backlash are important. Human-safety is difficult if the manipulator is to be used in close to the people. Arduino UNO R3 is used as the brain of the robotic arm, Flex sensors are placed at the gripper for finding the force applied on the object, and potentiometers are used at the joints for detecting the position of the motor shaft.

2. LITERATURE REVIEW

2.1. Wireless controlled robotic hand motion

This project studies composed with a glove with flexible sensor and 3D printed robotic arm. The robotic arm followed the action correctly with a maximum 0.133 ms time delay all the time. The results show that robotic movement can be detected from the sensor. Using components with low cost and high quality for 3D Printing the products.

2.2 Motion control strategy for free floating dual arm space robot

This project aims the desired trajectories for end-effectors of the space robot are designed to securely approach and prepare to capture the spinning object through synchronising with the grasp points, while at the same time the desired attitude of the base could be maintained. The results of this experiment shows that a motion control strategy has been developed for space controlled robots.

2.3 Design and construction of arduino operated open source robot.

The robotic system has four main components: an electromechanical robot arm structure, a control system, a Arduino UNO R3 Microcontroller, and a human-machine interface. The arm's purpose is to be a low-cost and replicable robot that aids the comprehension of robotics design through project-based learning. The results of this experiment show that design of highly customizable system that can be adapted to research and hazardous conditions.

2.4 Industrial arm-type robot

This aims having multiple degree of freedom. Six degree of freedom are traditionally considered to have larger workspace to perform dexterous motion control. The results of this shows that design, model, prototype, simulation and experimental verification 8 DOF redundant robot.

2.5 Intuitive kinematic control of redundant robotic arm

This project studied to track a specific end effector trajectory is achieved via haptic devices or homogenous robots with same degree of freedom and same mechanical structures. The results of the study show that kinematics of redundant robot manipulator via human motion. The advantage of this method is that a human can

teleoperate a robot to avoid obstacles with high end-point positional accuracy.

3. THEORETICAL INFRASTRUCTURE

The theoretical background of the project is examined below as main headings and subheadings.

3.1. SERVO MOTORS

Servo motors Detects the operation error of a mechanism, provides feedback and corrects faults. The servo motor can have alternating current (AC), direct current (DC) or stepper motors. In addition to these, there are drive and control circuits. Servo motors are the kinds of motors that can fulfill the commands we want. They can operate steadily even at very small or very large speeds. In these motors, the large moment can be obtained from the small size.

Servo motors are used in control systems such as fast operation, excessive axis movement, condition control and so on. Servo motors are the last control element of a mechanism. They are highly sensitive and servo motors are used in conjunction with electronic or programmable circuits. These engines are divided into AC and DC. When the AC servo motors are brushless type motors, the servo motors brush.

Servo motors are mostly three cables. These are a red cable for power, black for grounding and yellow cables for control (data, data). In the project Tower, Pro SG90 Mini servo motor is used. Some features of this servo motor; versatile operation, 10 μ s pulse width control, V_{p-p} : 3-5 V Square wave and working voltage of 4.8-6V. The used servomotor has a working

voltage of 0.12 s / 60 ° and a torque of 1.2-1.6 kg/cm at low operating voltage.

Servo motors are controlled according to the signal condition. In doing so, the supplied pulse width modulated (PWM) signal is used with the data bus. Each servo motor is controlled by a PWM signal at 10-20 ms and at 0.5-1.5 ms. the position of the motor shaft is determined according to the duration (t_k) of this signal at logic 1. These;

- When $t_k = 0.5$ ms, the motor shaft rotates to the end,
- When $t_k = 0.5 - 1$ ms, the position of the motor shaft is in the middle,
- When $t_k = 1 - 1.5$ ms, the motor shaft turns to the right,
- When $t_k = 10 - 20$ ms (when the same signal is given again) it remains in its old position,

The position control of these motors is determined using the required pulses. The servo motors DC used in the project are kept at about 5V during operation. One of the servomotors used in the production phase of the project is shown in Fig.3.1.



FIG 3.1 SERVO MOTOR

3.2. ARDUINO UNO R3 MICROCONTROLLER

Although microcontroller type PIC is usually used in programming and software field, Arduino has become very popular in the world in recent times. It is based on Arduino's past wiring and processing projects. Processing is written for non-programming users. Arduino wiring is produced on the basis of the programming language. The common feature of both is that it provides an environment where even the basic knowledge of electronics and programming can easily

design. Arduino is now becoming more and more common nowadays.

The causes of the spread of Arduino at such a rapid rate are;

- It can be used on all platforms due to the simplicity of the development
- It can be used on all platforms due to the simplicity of the development environment with driver usage.
- With the help of advanced library, even complex operations can be easily solved.
- Programs written in Arduino can run fast because they are not run on any other platform.
- There is a lot of hardware support that is compatible with Arduino and can work together.
- Communication with the environment it easy because it is open source.
- If there are any problems due to a large number of Arduino users, the solution can be easily reached.

ARDUINO UNO R3



FIG 3.2 ARDUINO UNO R3

3.3. CIRCUIT DIAGRAM

Circuit; Servo inputs, Arduino pin inputs. Servo motors are activated in this way, Arduino UNO connections and power supply connections are shown. It is possible to distribute the 5V from the power supply to the servo motors.

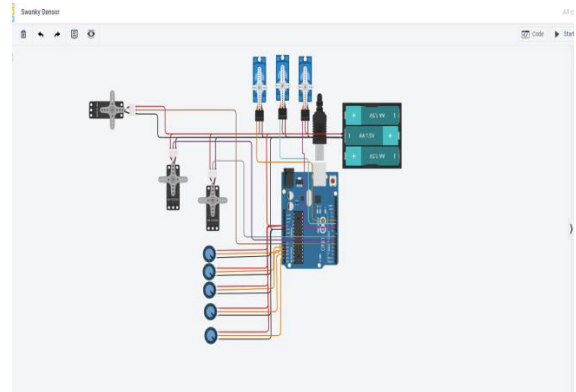

FIG 3.3 CIRCUIT DIAGRAM

3.4. BREADBOARD

A breadboard is a solderless device for temporary prototype with electronics and test circuit designs. Most electronic components in electronic circuits can be interconnected by inserting their leads or terminals into the holes and then making connections through wires where appropriate.

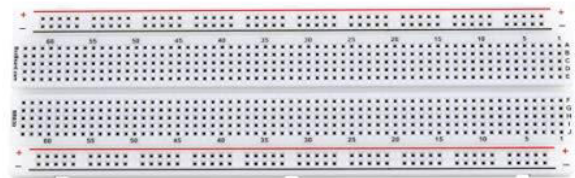

FIG 3.4 BREADBOARD

3.5. JUMP WIRES

A jump wire (also known as jumper, jumper wire, jumper cable, DuPont wire or cable) is an , or group of them in a cable, with a connector or pin at each end (or sometimes without them – simply "tinned"), which is normally used to interconnect the components of a or other prototype or test circuit, internally or with other equipment or components, without soldering. Individual jump wires are fitted by inserting their "end connectors" into the slots provided in a breadboard, the of a circuit board, or a piece of test equipment.

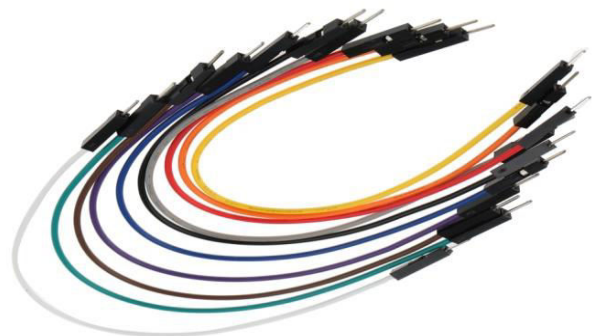

FIG 3.5 JUMP WIRES

3.6.POWER SUPPLY

The power supply selected for feeding the control circuit of the servomotors is capable of delivering the same current even if all the synchronous servomotors are operating. When all servo motors are operated at the same time, they draw 0.5A current. In addition, 5 V was needed for the Arduino used for robot movement in the project. This requirement is provided by a 5V power supply.

4.DESIGN BRIEF

The design part is divided into two parts, the mechanical part design, and the mechanical part installation. In the design of the mechanical part, drawings of the parts to be used in the robot arm construction were made through the help program. In the installation of the mechanical part, the naming of the servomotors used in the robot arm and the tasks during the operation of the robot are explained. The construction of the project consists of several steps. These steps are;

Determination of the mechanical materials required for the production of the project,
 Determination of microcontroller and software to be used in the project,

- Search and selection of servo motors that will run the robot arm in a proper way,
- Proper selection of mechanical parts,
- Implementation of robot arm assembly, Testing the system to see if it works properly with the microcontroller we choose,
- Possible faults have been given in the form of restructuring the system by passing through the eye.

These steps have been completed and the design of the robot has been completed. Arduino and robot arm control are used in the project material are given in the following chart.

5.ROBOTIC CONFIGURATION:

5.1 CARTESIAN CONFIGURATION:

The Cartesian Configuration provides for three linear axis of movement at right angles to each other. The modes of movement are similar to those on a milling

machine, providing movement in the X, Y and Z axis. It can also be called Rectangular Configuration as its working range sweeps a rectangular volume.

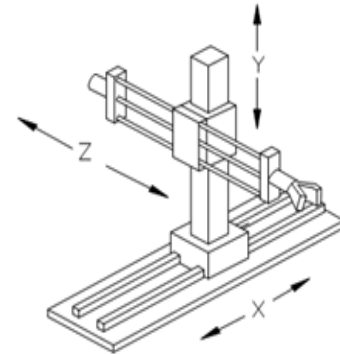
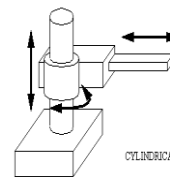

FIG 5.1 CARTESIAN CONFIGURATION

5.2.CYCLINDRICAL CONFIGURATION:

The Cylindrical configuration combines both vertical and horizontal linear movement, with rotary movement in the horizontal plane about the vertical axis.



5.2 CYLINDRICAL CONFIGURATION

5.3POLAR CONFIGURATION:

Polar robots are robot configurations with a combined linear joint and two rotary joints, with an arm connected to a robotic base and a twisting joint. Also known as spherical robots, the axes create a spherical work envelope and a polar coordinate system. Spherical robots are well-known in the history of robotics.

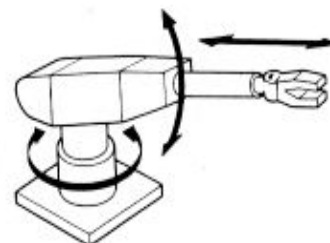

5.3 POLAR CONFIGURATION

5.4 JOINT ARM CONFIGURATION:

An articulated robot arm is a robot with rotary joints. They are also known as a jointed-arm robots. The articulated robot arm has a trunk, shoulder, upper arm, forearm, and wrist. With the ability to rotate all the joints, a majority of these robots have six degrees of freedom.

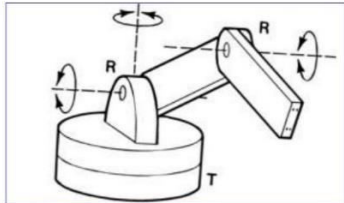

Jointed-arm body-and-arm assembly (TRR).

5.4 JOINT ARM CONFIGURATION 5. MECHANICAL DESIGN

Materials needed for the mechanical part of the robot arm were supplied, and then the materials were drawn on Tinkercadd. The mechanical part was assembled with these materials. The Designs are given Below

5.1.3D DESIGN ARM



FIG 5.1 ARM

5.2 3D DESIGN HIP



FIG 5.2 HIP

5.3 3D DESIGN OF BASE



FIG 5.3 BASE

6. MECHANICAL PART MOUNTING

The cut parts are assembled together with the servo motors and assembly of the robot arm is completed. The robot arm moves by 5 axes and performs this movement with 6 Mini Servo Motors.

After drawing the parts on TINKERCADD and making the necessary parts, the design of the mechanical part is started and the robot arm is made of a stationary lower body and movable upper body. There is one servo motor in the stationary lower part of the robot arm and this robot is called axis 1. The 1st axis provides rotation of the robot arm to the right or left. There are 2 servo motors in the moving upper body part. Since these servo motors must operate parallel to each other, both start and end positions are set simultaneously. These two servo motors are named as 2nd axis and 3rd axis respectively.

The tasks of 2nd and 3rd axes are to move the robot arm up and down. Mounting of servo motors in 1st and 2nd and 3rd axes.

7. EXPERIMENTAL STUDIES

Experimental studies are within themselves; the method followed in the project, robot arm control system, and programming. In the method and robot arm control system part of the project, the basic commands are explained after the basic information is given and the robot can perform the required tasks. In the program section, there is the software information required for the movement of the robot.

The programming part of the program is given in Appendix to the project to make the project more regular.

8. PROJECTED METHOD

First, a historical research on robot arms was carried out and the basic information needed to establish the system was obtained. The robot used in the project types with arm joint and can move in 4 axis directions (left and right, up and down) and also can hold and swing motion thanks to the holder on it. The microcontroller Arduino Nano is used to provide optimal control of the robot arm.

The reason for preferring this microcontroller is that it is more accessible to be able to get a solution to a possible error because the open source code is easier to use than the other microcontrollers and the number of users is higher. After these studies, detailed information has been obtained about the servo motors to be used. The servomotor is preferred because it can be carried out smoothly in the robot project, the motor can be operated precisely and it must be at high torque. The robot arm, 5 servo motors are formed. Servo motors are numbered from top to bottom in order to explain their tasks because of the excess.

9. RESULT AND DISCUSSION

Here we are having four pots provided to the user that is by rotating these four pots, we supply variable voltage at the ADC channels of UNO. So the digital values of Arduino are under control of user. These digital values are to adjust the servo motor position, thus the servo position is in control of user and by rotating these pots we can move the joints of Robotic arm and we can pick or grab or place any object. The voltage across variable resistors is not completely linear it will be a noisy one. So to filter out this noise, capacitors are placed across each resistor. Robotic Arm is controlled by four Potentiometer, and we control it with the help of servo motor, We can move these servos by rotating the potentiometer to pick objects, with some practice we can easily pick and move the object from one place to another. We have used low torque servos here but we can use more powerful servos to pick heavy object.

The below model shows the complete working of the robotic arm that is how each potentiometer is fixed and how each individual pot controls the rotation of the

servo

motors.



Motion Control Robotic Arm

Arm and the whole circuit it works accordingly when we apply a 5V supply to the system and we get a suitable output. Thus representing how it works accordingly. Still there is a problem of vibration in the system that can reduce in the future enhancement that is maybe we can use high power servo motor and by the help of it vibration can be reduced even the grabbing power is less that it can pick a very heavy object just a lighter object.

In future this structure can be modified and made of heavier materials and power servo or either accelerometer or simple ac, dc motors thus we will get a structure that would be able to pick object easily and grab heavy object easily and act like a perfect crane. show the representing whole robotic arm and show the connections with arduino.

Future Scope

The future scope of motion Controlled Robotic Arm is in hazardous environments like radioactive applications and High Electric Applications, where human interactions are low setup can be modified that will pick more weight compared to present model. Ultrasonic sensor can even be placed on the arm so that it can detect and simultaneously pick the object and keep it on other place.

Conclusion

This proposed work is an overview of how we can make use of servo motor to make joints of a robotic arm and control it using potentiometer and arduino UNO. Also used for high loaded industrial application work. This system would make it easier for man to unrivalled the risk of handling suspicious objects which could be hazardous in its present environment and workplace. Complex and complicated duties would be achieved faster and more

REFERENCES

- [1]. Kurt E. C, Shang Y, A Geometric approach for the robotic arm kinematics with hardware design, Electrical design and implementation, Journal of robotics, 2010, Volume 10.
- [2]. Rahman A, Khan A. H, Dr. Ahmed T, Md Sajjad M, Design analysis and Implementation of Robotic arm – The Animator, American Journal of Engineering Research, 2013, Volume 2, Issue 10.
- [3]. Gautam R, Gedam A, Zade A, Mahawadiwar A, Review on Development of Industrial robotic arm, IRJET, March 2017, Volume 4, Issue 3
- [4] WMHW Kadir, RE Samin, BSK Ibrahim. Internet controlled a robotic arm. Procedia Engineering. 2012.
- [5] MAK Yusoff, RE Samin, mobile robotic arm. Procedia Engineering. 2012.
- [6] AM Al-Busaidi, Development of an educational environment for online control of a biped robot using MATLAB and Arduino, (MECHATRONICS), 9th France-Japan.2012.

WEB REFERENCES :

WWW.GITHUB.COM

www.bildr.com

<http://www.arduino.cc>

<http://bildr.org/2011/06/13g4200d-arduino/>

<http://www.billporter.info/2011/05/30/easyt-transfer-arduino-library/>