

DESIGN OF INTERLEAVED BUCK CONVERTER FOR ELECTRIC VEHICLE FAST CHARGING

K.Anitha, K Charan Sai, B Ganesh Gupta, B Venkatesh, A Akhil
Department of Electrical & Electronics Engineering
Lendi Institute of Engineering and Technology, Vizianagaram

Abstract: DC-DC converters are very important part of the Plug in Hybrid Electric Vehicles for charging. The main objective of this project is to Design and Simulation of Interleaved buck converter for electric vehicle fast charging. As compare to buck converter the interleaved buck converter is better. In buck converter switching losses and inductor ac losses are more and efficiency is less. The interleaved buck converter works in continuous conduction mode so the current stress is less. The voltage stress across switches is half of input voltage before switch on and switch off conditions. So, the switching losses are less and efficiency is high. The performance of the converter is to be observed with MATLAB/SIMULINK.

Keywords— 12 Pulse converters, Interleaved buck converter., Buck converter.

1.INTRODUCTION

The increasing number of electric vehicles demands increasing of battery charging stations. As a result, the battery charging infrastructure has a crucial role in the success of transportation of electrification. In terms of charging levels, EVs can be charged at 3 different power levels. In the first level, vehicle stays connected to the 110V AC grid for approximately 8 to 12h for a full charge, with a power level up to 1.9kW. The second charge level, the vehicle's batteries are charged with a power up to 19.2kW, while the car is connected to a 220V AC grid, for 4 to 6h. The third level is considered fast charge because the charger is placed outside the vehicle and its power can reach up to 90kW. For this quick charge, the DC source takes 30min to charge the vehicle up to 80% of its battery capacity. When connected to the station, the vehicle requires a desired current level depending on connectors type. Each fast charge connector type has a limit for the maximum output voltage and current.

Today, fast charge stations have power levels higher than 45kW. In order to process the different converter topologies can be used. Among the converter topologies, the interleaved buck

converter is employed in charging stations, since it is simple, reliable and efficient. Let us consider a KW with a A maximum current is required for a charging station. This current demand can be handled by an interleaving leg of buck converters since the power flow is unidirectional. In addition to the output current ripple frequency is multiplied by the number of legs, contributing to the reduction of passive components. The high output frequency makes it possible to achieve a better transient response as well. Other advantages that includes reduced input and output capacitor RMS currents, reduced filter requirements and a better performance of system.

In this paper we are discussing about the interleaved buck converter. Interleaving technique connects dc-dc converter in parallel to share the power flow between two or more conversion chains. It implies a reduction in the size, weight and volume of the inductors and capacitors. Also, a proper control of the parallel converters increases the ripple frequency and reduces the ripple waveforms at the input and output of the power conversion system, which leads to a significant reduction of current and voltage ripples. Since it has the simple structure and low control complexity interleaved buck converter is used in applications where non isolation, step down conversion ratio, high output current with low ripple is required.

There are two active switches connected in series whereas capacitor provide power path. At 180 phase angle active switches are driven and by maintaining duty ratio is below 50% at switching frequency output voltage can be regulated. Current stress is less when interleaved buck converter operates in continuous conduction mode. When converter is in steady state voltage stress becomes half of input voltage after switch off and before switch on. Capacitor starts discharging

and switching losses decreases.

Table1: Different Levels of Charging

Power Level Types	Charger Location	Typical Use	Expected Power Level	Charging Time	Vehicle Technology
Level 1 (Opportunity) 120 Vac 230 Vac	On-board 1-phase	Charging at home or office	1.4kW (12A) 1.9kW (20A)	4–11 hours 11–36 hours	PHEVs (5-15kWh) EVs (16-50kWh)
Level 2 (Primary) 240 Vac 400 Vac	On-board 1 or 3 phase	Charging at private or public outlets	4kW (17A) 8kW (32 A) 19.2kW (80A)	1–4 hours 2–6 hours 2–3 hours	PHEVs (5-15 kWh) EVs (16-30kWh) EVs (3 – 50kWh)
Level 3 (Fast) (208-600 Vac)	Off-board 3-phase	Commercial or filling station	50kW 100kW	0.4–1 hour 0.2–0.5 hour	EVs(20–50kWh)

2. BUCK CONVERTER

There are three basic types of dc-dc converter circuits, termed as buck, boost and buck-boost. In which we are using Buck Converter In this circuits, a power device is used as a switch. This device earlier used was a thyristor, which is turned on by a pulse fed at its gate. In all these circuits, the thyristor is connected in series with load to a dc supply, or a positive (forward) voltage is applied between anode and cathode terminals. The thyristor turns off, when the current decreases below the holding current, or a reverse (negative) voltage is applied between anode and cathode terminals. So, a thyristor is to be force-commutated, for which additional circuit is to be used, where another thyristor is often used. Later, GTO's came into the market, which can also be turned off by a negative current fed at its gate, unlike thyristors, requiring proper control circuit. The turn-on and turn-off times of GTOs are lower than those of thyristors. So, the frequency used in GTO-based choppers can be increased, thus reducing the size of filters. Earlier, dc-dc converters were called 'choppers', where thyristors or GTOs are used. It may be noted here that buck converter (dc-dc) is called as 'step-down chopper'.

3. INTERLEAVED BUCK CONVERTER

Interleaving technique connects dc-dc converter in parallel to share the power flow between two or more

conversion chains. It implies a reduction in the size, weight and volume of the inductors and capacitors. Also a proper control of the parallel converters increases the ripple frequency and reduces the ripple waveforms at the input and output of the power conversion system, which leads to a significant reduction of current and voltage ripples. Due to the simple structure and low control complexity of interleaved buck converter, it is used in applications where non isolation, step down conversion ratio, high output current with low ripple is required.

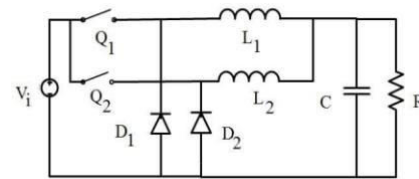

Fig1.: Interleaved buck converter

When switch Q₁ turns ON and Q₂ turns OFF inductor L₁ charges and L₂ discharges and freewheels through the diode. The inductor current flows through the diode, transferring some of its stored energy to the load.

$$V_{L1} = V_i - V_o$$

$$V_{L2} = -V_o$$

When both Q₁ and Q₂ turns OFF, the both inductors L₁ and L₂ discharges and freewheels through D₁ and D₂. The equations are,

$$V_{L1} = V_{L2} = -V_o$$

When Q₂ turns ON, the inductor L₂ charges and L₁ discharges and freewheels through the diode D₁.

$$V_{L1} = -V_o$$

$$V_{L2} = V_i - V_o$$

In IBC the active switches suffer from the input source voltage due to its parallel connection with the source. So high voltage devices should be used. But high voltage rated devices is characterized with high forward voltage drop, high cost, intense reverse recovery, high on resistance. Due to the hard switching condition, the operating efficiency is very poor. For getting good dynamics and higher power density converter requires to operate at higher switching frequency. But at higher switching frequency switching losses is increased and thus, efficiency is further reduced.

3. SIX-PULSE CONVERTERS

The circuits of Fig. 1 result when an attempt is made to use the power transformers themselves as current sharing components. In these circuits nearly equal secondary currents are ensured even in the face of slight differences in winding ratios by wiring the transformer primaries in series. Furthermore, complex wiring has been transferred to the high-voltage side of the circuit where lighter gauge conductors make it less cumbersome. The use of two three-phase transformers with one secondary winding instead of one three-phase transformer with two secondaries is offset by the fact that at high power levels, transformers are basically sold by the pound and the total transformer rating is not changed. Since some components have been eliminated, there seems to be a net gain.

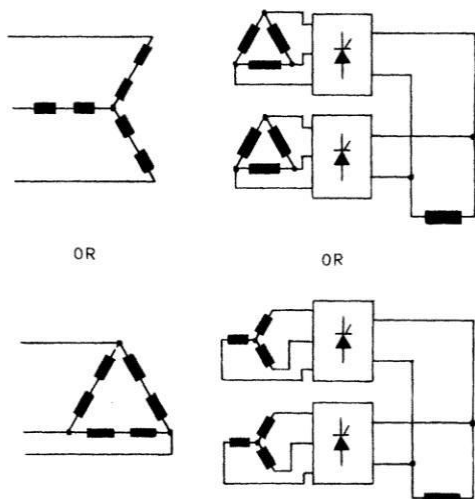

Fig.2. Six-pulse converters, four possible configurations: star-delta, Star-star, delta- delta, and delta- star.

4. TWELVE PULSE CONVERTERS

Many high-current, low-voltage rectifier applications, such as electroplating, exceed the capacity of the largest available semiconductors and require some form of parallel connection. Direct paralleling of semiconductor devices is of very little help for well-known reasons, and Elaborate current sharing schemes become necessary.

Classical solutions, for simple converters, involve resistive current sharing networks and load sharing inductors or

Transformers. For more elaborate converters, parallel bridges May be used, but the current sharing problem remains since any dissymmetry between the transformers would result in severe current unbalance. This is partly offset by the use of 12-pulse converters, but in order to get full utilization of transformer and semiconductor ratings interphase transformers must be used. These are subject to severe saturation problems requiring them to have air gaps and consequently increasing their size. Furthermore, all of these schemes require complex wiring on the low voltage (busbar) side of the converter.

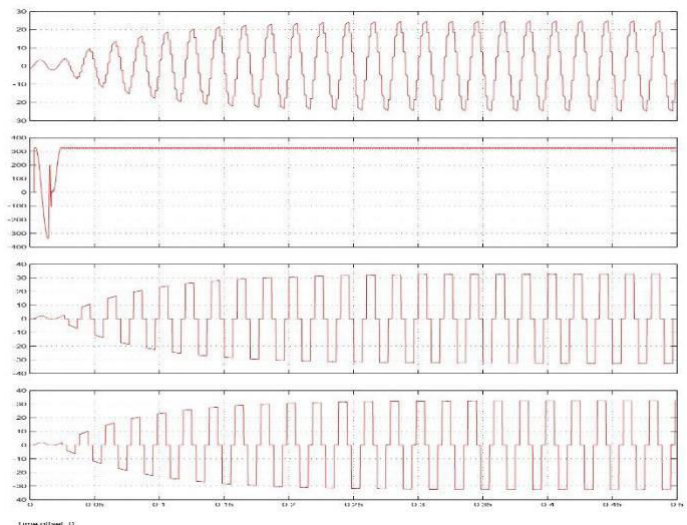
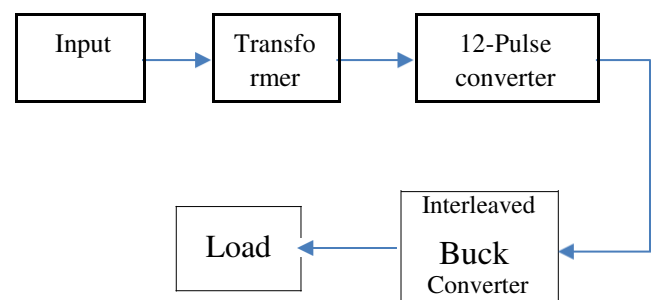

Fig.3 Simulation performance of the 12-pulse converter.

5. BLOCK DIAGRAM



6. MATLAB RESULTS AND DISCUSSION

The simulation performance of the Different Converters for Electric Vehicles is carried out using MATLAB/Simulink. These are as follows: (a) Without using any Converter, (b) With Buck converter and (c) With Interleaved Buck converter. The

simulation and performance of the different converter are illustrated in respectively.

6.1 System performance without using converter

To analyze the performance of the system without using any converter. The load is maintained through out the time of simulation under constant condition. The different subplots like supply voltage (), supply current (), and load current () are depicted in Fig.3.

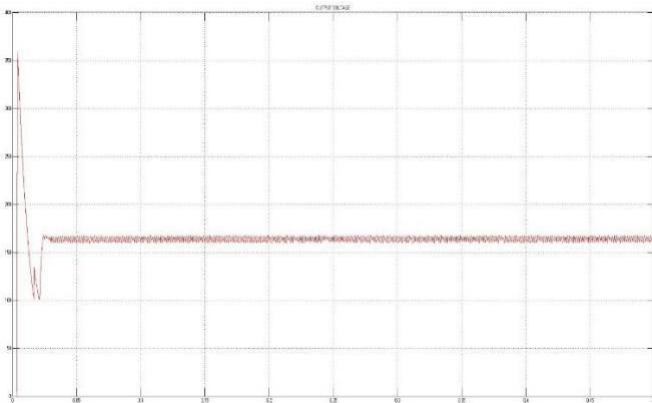

Fig.4 Simulation performance of the system without using converter.

6.2 System performance with Buck converter:

To analyze the performance of the system without using any converter. The load is maintained through out the time of simulation under constant condition. The different subplots like load current () and load voltage () are depicted in Fig.4

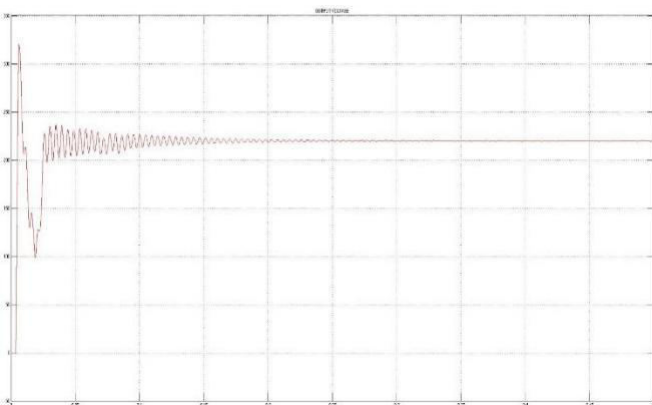

Fig.5 Simulation performance of the system with Buck converter.

From the simulation results, it has been found that the performance of the system using the Buck converter is not suitable Electric vehicle charging system, why because the losses of converter are more and the load voltage which is obtained is not in the required range. So this problem can be achieved by using interleaved buck converter. In interleaved buck converter the losses are less and load voltage is obtained within the required range for electrical vehicle charging system. The load is maintained through out the time of simulation under constant condition. The interleaved buck converter configuration as follows.

6.3 System performance with Interleaved Buck converter:

To analyze the performance of the system without using any converter. The load is maintained through out the time of simulation under constant condition. The different subplots like load current () and load voltage () are depicted in Fig.5

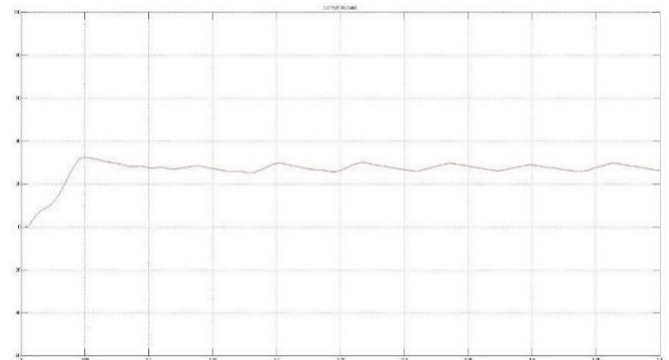

Fig.6 Simulation performance of the system with Interleaved Buck converter.

7. CONCLUSION

An interleaved buck converter is an alternative for electric vehicles DC fast charge stations and in this paper presented the comparison of buck converter and interleaved buck converter is done on the basis of harmonics and efficiency. From simulation concepts, it is verify that as compare to Buck converter, Interleaved buck converter is better. Because the total harmonic distortion is less in Interleaved buck converter whereas total harmonic distortion is more in buck converter. Also Efficiency is more in modified interleaved buck converter

whereas it is low in buck converter. So finally the interleaved buck converter is very useful for Electrical vehicle charging system.

Table 2: Different converter parameters:

Parameters	Without Converter	With buck Converter	With Interleaved Buck Converter
Input voltage	415volts	415 volts	415volts
Load voltage	200-300 volts	220 volts	25 volts
Load current	2-3 amps	1-2 amps	1-2 amps

REFERENCES

- CHAdeMO DC Charging Connector. Technical Edition 3, 2016.
- Jia Ying Yong, Vigna K. Rama Candara Murthy, Kang Miao Tan, and N. Mithulananthan. A review on the state-of-the-art technologies of electric vehicle, its impacts and prospects. *Renewable and Sustainable Energy Reviews*, 49:365–385, 2015.
- J. Channegowda, V. K. Pathipati, and S. S. Williamson. Comprehensive review and comparison of dc fast charging converter topologies: Improving electric vehicle plug-to-wheels efficiency. In 2015 IEEE 24th International Symposium on Industrial Electronics (ISIE), pages 263–268, June 2015.
- Krishna P.S, Jubin Eldho Paul and Hari Kumar R “Study and analysis of conventional and modified interleaved buck converter” *International journal of research and general science*, vol.3, issue6, Nov-Dec,2015.
- A. Colvero Schittler, D. Pappis, A. Campos, M. A. Dalla Costa, and J. M. Alonso. Interleaved buck converter applied to high-power hid lamps supply: Design, modeling and control. *IEEE Transactions on Industry Applications*, 49(4):1844–1853, July 2013.
- Il-Oun Lee; Shin-Young Cho; Gun-Woo Moon, "Interleaved buck converter having low switching losses and improved step-down conversion ratio," *IEEE Trans. Power Electron*, vol.27, no.8, pp.3664,3675, Aug. 2012.
- Mohamed. A. Shrud, Ahmad Kharaz, Ahmed. S. Ashur, Mustafa Shater and Ismail Benyoussef “A Study of Modeling and Simulation for Interleaved Buck Converter” *IEEE International Conference in Power Electronic & Drive Systems & Technologies* 2010. PP 28-35.
- C. T. Tsai and C. L. Shen, “Interleaved soft-switching coupled-buck converter with active-clamp circuits,” in *Proc. IEEE Int. Conf. Power Electron. Drive Syst.*, 2009, pp. 1113–1118
- G. Oliver, G. E. April, E. Ngandui and C. Guimaraes, “Novel Transformer Connection to Improve Current Sharing on High Current DC Rectifier,” *IEEE IAS*, pp.986-962, 1993.