

# DESIGN OF THREE PHASE SPACE VECTOR PWM INVERTER WITHOUT TRANSFORMATION

M KARTHICKPRABU<sup>1</sup>| DR. V GEETHA<sup>2</sup>

<sup>1</sup> PG Scholar, Department of EEE, Government College of Engineering Salem, Tamil Nadu, India

<sup>2</sup>Professor and Head , Department of EEE, Government College of Engineering Salem, Tamil Nadu, India.

**ABSTRACT** - The rapid development of high switching frequency power electronics in the past decade leads towards wider application of Voltage Source Inverter (VSI) in the AC power generation. Therefore ,this prompts the needs for a modulation technique with less Total Harmonic Distortion (THD) and fewer switching losses. Space Vector Pulse Width Modulation is a better technique for generating a fundamental sine wave that provides a higher voltage ,higher reduction in the dominant harmonics and lower total harmonics distortion and it utilizes DC source effectively. This paper introduces an SVPWM technique based on a reduced computation method, which is much simpler and fast executable than conventional means without lookup tables or complex logical judgements.

In SVPWM method, a revolving reference voltage vector is provided as the voltage reference instead of three phase modulating waves. The magnitude and frequency of the fundamental component in line side are controlled by the magnitude and frequency of the reference vector. The practical design is modelled using the MATLAB SIMULINK (R2013a) software package.

**Key words:** Space Vector Pulse Width Modulation, Total Harmonics Distortion, Switching loss, Voltage Source Inverter.

## 1. INTRODUCTION

Voltage source inverters are widely used in many industrial applications such as motor drives, uninterruptible power supplies (UPS),frequency converters and the active filters. The main objective of the voltage source inverters is to synthesize AC output voltage and frequency from a constant DC voltage via pulse width modulation technique [1]. Pulse width modulation technique have been developed to achieve the following aims: Wide linear modulation range, fewer switching losses, low total harmonics distortion (THD) and less computational time .

Driving voltage source inverter is made by one of two popular PWM techniques, namely the Sinusoidal PWM technique (SPWM) and Space Vector PWM technique. In SVPWM scheme, the reference voltage space vector is realized by switching between the nearest three inverter voltage space vectors which forms the sector in which the reference vector resides [2]. Each of the combined inverter voltage space vector is realized by switching a combination of the individual inverter voltage space vector.

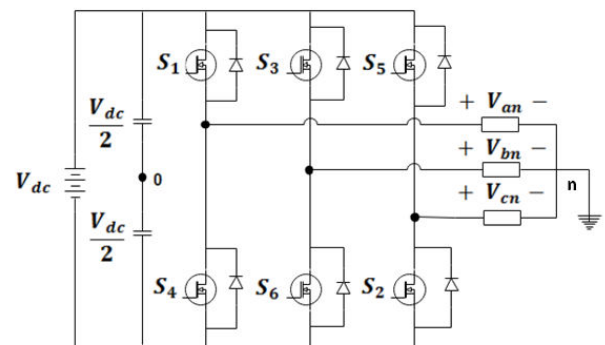

**Fig - 1 Three-phase voltage source PWM Inverter**

Generally, Space Vector PWM implementation involves sector identification, switching time calculation, switching vector determination and optimum switching sequence selection for the inverter voltage vector. The sector identification can be done by co-ordinate a-b-c to d-q transformation. The look up tables can be used for determining the switching vectors in the best switching sequence.

The objective of this paper is to introduce a simplified SVPWM technique in which the inverter leg switching times are directly obtained from the instantaneous sampled reference phase voltages and the inverter switching vectors are generated automatically[3]. This method is more simpler and fast executable than conventional means without co-ordinate a-b-c to d-q transformation.

## 2. BASIC PRINCIPLE OF SPACE VECTOR PWM

The space vector principle which can be derived from the rotating field of electric motor, is used for modulating the inverter output voltage[4]. In this modulation technique the three phase quantities (a, b, c) can be transformed to their equivalent two phase quantity in the stationary frame (d, q).

When three phase voltage is applied to the AC machine, it produces a rotating flux in the air gap of the machine. This resultant rotating flux can be represented as

single rotating voltage vector. The magnitude and angle of the rotating vector can be calculated by means of Clark's transformation[5]. To implement the space vector PWM, the voltage equations in the a-b-c reference frame can be converted into the stationary d-q reference frame. The relation between these two reference frames in matrix form is given by

$$\begin{bmatrix} V_d \\ V_q \end{bmatrix} = \frac{2}{3} \begin{bmatrix} 1 & -1/2 & -1/2 \\ 0 & \sqrt{3}/2 & -\sqrt{3}/2 \end{bmatrix} \begin{bmatrix} V_{an} \\ V_{bn} \\ V_{cn} \end{bmatrix} \quad (1)$$

In three phase inverter, there are six power switches that shape the output waveform. There are only eight possible switching vectors. Six out of these eight vectors produces a non zero voltage which are known as non zero switching states. The remaining two vectors produces zero output voltage and known as zero switching states[6]. The six active vectors divide the space vector plane into six equal sized sectors of 60° with equal magnitude which forms an origin central hexagon and two zero space vector near to origin.

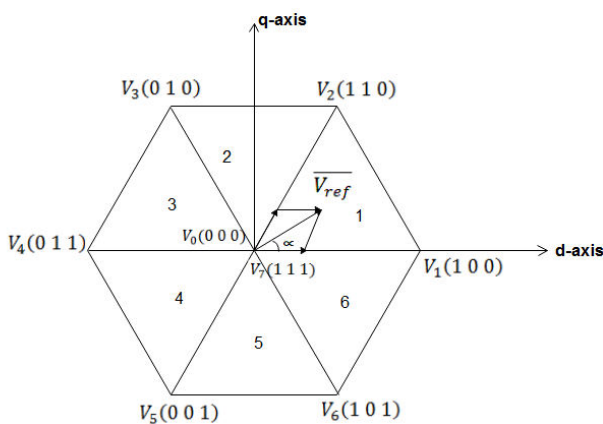

Fig - 2 Switching vectors and sectors

Eight possible combinations of on and off patterns may be achieved . The ON and OFF states of lower switches are the inverted states of upper ones[7]. The phase voltages corresponding to eight combinations of switching patterns can be calculated and then converted into the stator two phase reference frames. The transformation results in six non-zero voltage vectors and two zero vectors. The non zero vectors forms the axes of hexagon containing six sectors( $V_1 - V_6$ ).The angle between any adjacent two non zero vector is 60 electrical degree[8]. The objective of SVPWM technique is to approximate the reference voltage vector  $\overline{V_{ref}}$  using the eight switching patterns. One of the simpler method of approximation is to generate the average output of inverter in a small period T to be the same as that of  $\overline{V_{ref}}$  in a same period[9]. The magnitude and angle of rotating vector  $\overline{V_{ref}}$  can be calculated in terms of  $V_q$  and  $V_d$  is given by

$$|\overline{V_{ref}}| = \sqrt{V_d^2 + V_q^2} \quad (2)$$

$$\alpha = \tan^{-1} \left[ \frac{V_q}{V_d} \right] = \omega t = 2\pi ft \quad (3)$$

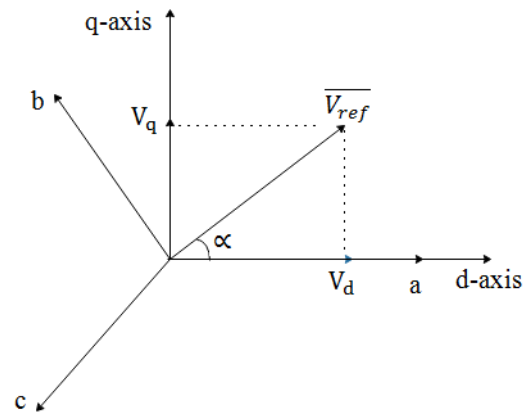

Fig - 3 Voltage space vector and its components in (d,q).

In Figure-4, during the sampling interval  $T_s$ , the reference voltage  $\overline{V_{ref}}$  remains steady and then the switching states 0,1,2 and 7 can be used. Implementing the conventional SVPWM,  $\overline{V_{ref}}$  can be expressed as

$$\int_0^{T_s} \overline{V_{ref}} dt = \int_0^{T_0} \overline{V_0} dt + \int_0^{T_1} \overline{V_1} dt + \int_0^{T_2} \overline{V_2} dt + \int_0^{T_7} \overline{V_7} dt \quad (4)$$

$$\overline{V_{ref}} T_s = \overline{V_0} T_0 + \overline{V_1} T_1 + \overline{V_2} T_2 + \overline{V_7} T_7 \quad (5)$$

Equation(4) shows the inverter is in active state 1 for a period  $T_1$  and it is in active state 2 for a period  $T_2$ .For the remaining time of the sampling interval period  $T_s$ , there is no voltage applied. This can be achieved by applying inactive state 0 or 7 for the remaining time  $T_0$  or  $T_7$ .

To generate this vector in an average sense, the durations for which the active state 1 , the active state 2 and the two zero states together must be applied which are given by  $T_1, T_2$  and  $T_z$  respectively, obtained as:

$$T_1 = \overline{V_{ref}} \sin(60^\circ - \alpha) \quad (6)$$

$$T_2 = \overline{V_{ref}} \frac{\sin(\alpha)}{\sin(60^\circ)} \quad (7)$$

$$T_z = T_s - (T_1 + T_2) \quad (8)$$

where,

$$T_z = \frac{T_0 + T_7}{2} \tag{9}$$

$\alpha$  is the angle of rotating vector  $\overline{V_{ref}}$ .

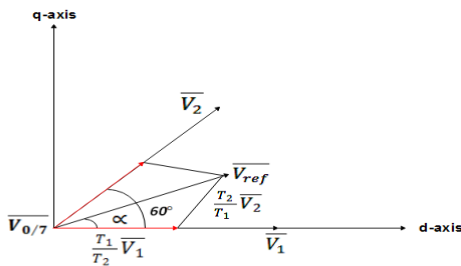

**Fig - 4 Reference vector as a combination of adjacent vectors at sector-1.**

The division of the duration  $T_z$  between the two zero vectors  $T_0$  or  $T_7$  is a degree of freedom in the space vector approach. This division of  $T_z$  in a sub cycle is equivalent to adding a common mode component to the three phase average pole voltages.

### 3. SWITCHING STATES

For 180° mode of operation in VSI, there are six non-zero switching states and additionally two zero switching states[10]. It is essential for make all three switches of either upper arms or lower arms on the upper and lower switches are commutated in complementary fashion, so that it is enough to represent the status of either upper or lower arm switches.

In table-1 ,status of the upper arm switches represented and lower arm switches will its complementary. Let "1"denotes the switches are ON and "0"denotes the switches are OFF.

**Table - 1 Switching vectors and respective line to neutral voltage**

Voltage vector	Switching vector			Line to neutral voltage		
	A	B	C	$V_{an}$	$V_{bn}$	$V_{cn}$
$V_0$	0	0	0	0	0	0
$V_1$	1	0	0	$2/3$	$-1/3$	$-1/3$
$V_2$	1	1	0	$1/3$	$1/3$	$-2/3$
$V_3$	0	1	0	$-1/3$	$2/3$	$-1/3$
$V_4$	0	1	1	$-2/3$	$1/3$	$1/3$
$V_5$	0	0	1	$-1/3$	$1/3$	$2/3$
$V_6$	1	0	1	$1/3$	$-2/3$	$1/3$
$V_7$	1	1	1	0	0	0

### 4. SVPWM USING A REDUCED COMPUTATIONAL METHOD

This method is based on the principle of equivalence of Space Vector PWM (SVPWM) with Sinusoidal PWM (SPWM) can be generate the SVPWM signal directly from the instantaneous reference phase voltage.

The steps involved in implementation of SVPWM using a reduced computational method are:

#### STEP-1 Determine $V_{ref}$ and angle ( $\alpha$ ):

The magnitude and angle of  $V_{ref}$  can be obtained by the phase lock loop(PLL) from the single sinusoidal voltage signal. This voltage signal is taken from one of the phase of three phase system. The phase lock loop (PLL) closed loop control system tracks the frequency and phase of a sinusoidal signal by using an internal frequency oscillator. The control system adjusts the internal oscillator frequency to keep the phase difference to "0".

#### STEP-2 Determine the time duration $T_0, T_1, T_2$ :

From figure - 4 ,the switching time duration for the sector -1 can be calculated as follows:

$$\int_0^{T_s} \overline{V_{ref}} dt = \int_0^{T_0} \overline{V_0} dt + \int_0^{T_1} \overline{V_1} dt + \int_0^{T_2} \overline{V_2} dt + \int_0^{T_7} \overline{V_7} dt \tag{10}$$

$$\overline{V_{ref}} T_s = \overline{V_0} T_0 + \overline{V_1} T_1 + \overline{V_2} T_2 + \overline{V_7} T_7 \tag{11}$$

$$|\overline{V_{ref}}| (\cos \alpha + j \sin \alpha) T_s = 2/3 V_{dc} T_1 + 2/3 (\cos 60^\circ + j \sin 60^\circ) T_2 \tag{12}$$

$$T_1 = T_s \cdot a \cdot \frac{\sin(60^\circ - \alpha)}{\sin 60^\circ} \tag{13}$$

$$T_2 = T_s \cdot a \cdot \frac{\sin(\alpha)}{\sin 60^\circ} \tag{14}$$

where,  $(0 \leq \alpha \leq 60^\circ)$

$$T_0 = T_s - (T_1 + T_2) \tag{15}$$

where,  $T_s = 1/f_s$  and  $a = \frac{|\overline{V_{ref}}|}{\frac{2}{3}|V_{dc}|}$

Switching time duration of any sector is given by

$$T_1 = \frac{\sqrt{3} T_s |\overline{V_{ref}}|}{V_{dc}} \left( \sin \left( 60^\circ - \alpha + \frac{n-1}{3} \pi \right) \right) \tag{16}$$

$$T_1 = \frac{\sqrt{3} T_s |\overline{V_{ref}}|}{V_{dc}} \left( \sin \left( \frac{n}{3} (\Pi - \alpha) \right) \right) \tag{17}$$

$$T_2 = \frac{\sqrt{3} T_s |\overline{V_{ref}}|}{V_{dc}} \left( \sin \left( \alpha - \frac{n-1}{3} \pi \right) \right) \tag{18}$$

$$T_0 = T_s - (T_1 + T_2) \tag{19}$$

{where, n = 1 through (that is sector 1 to 6)}  
{ $0 \leq \alpha \leq 60^\circ$ }

$$T_1 = \overline{V_{ref}} \sin(60^\circ - \alpha)$$

$$T_2 = \overline{V_{ref}} \frac{\sin(\alpha)}{\sin(60^\circ)}$$

$$T_0 = T_s - (T_1 + T_2)$$

**Step-3 Determine the switching time of each MOSFET ( $S_1$  to  $S_6$ )**

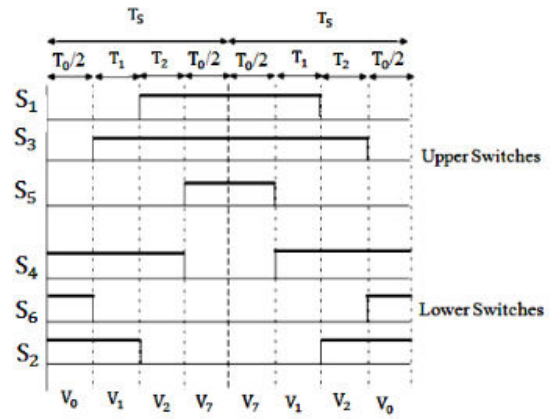

Fig - 7 Sector- 3

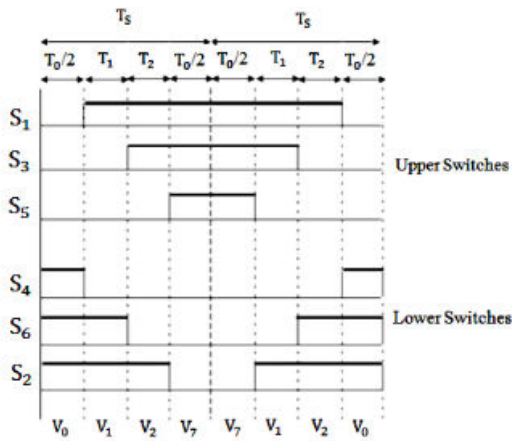

Fig - 5 Sector- 1

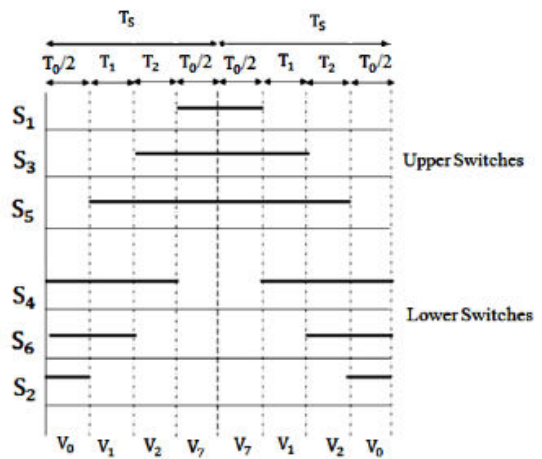

Fig - 8 Sector- 4

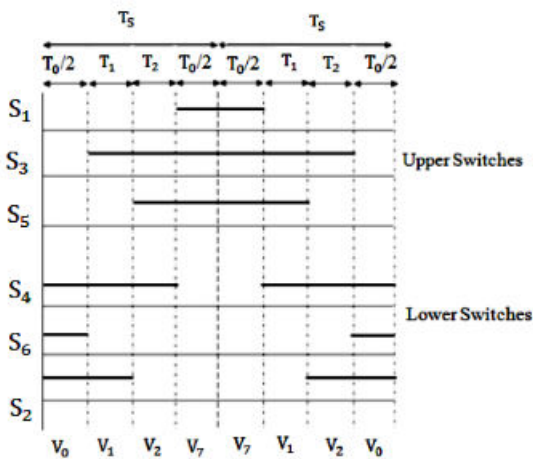

Fig - 6 Sector- 2

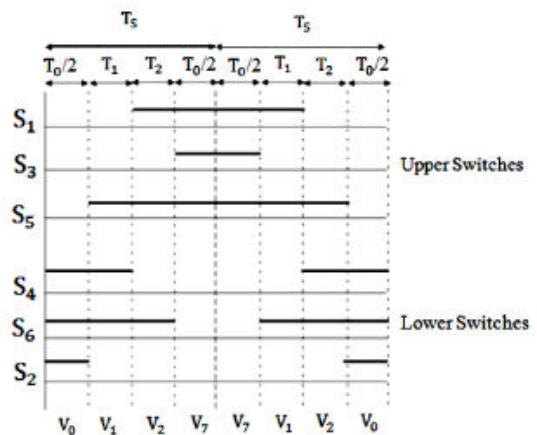

Fig - 9 Sector- 5

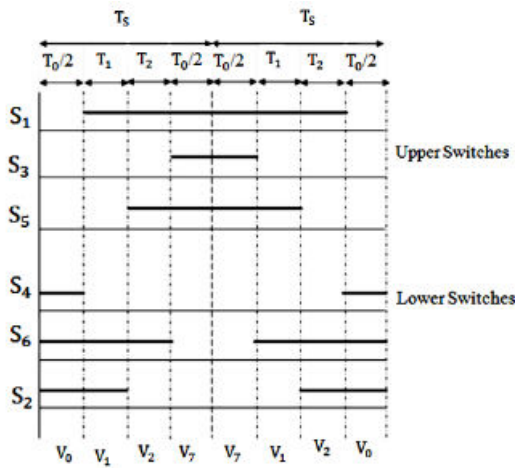

Fig - 10 Sector- 6

5. SIMULATION RESULTS

The practical system is modelled and simulated using MATLAB SIMULINK (R2013a) software package. The MATLAB SIMULINK model is as shown in figure-5.

The simulation is performed under the following conditions: Input voltage =600Vdc. Output voltage fundamental harmonic  $f=50\text{Hz}$ , Switching frequency  $f_{sw}=20\text{KHz}$ .

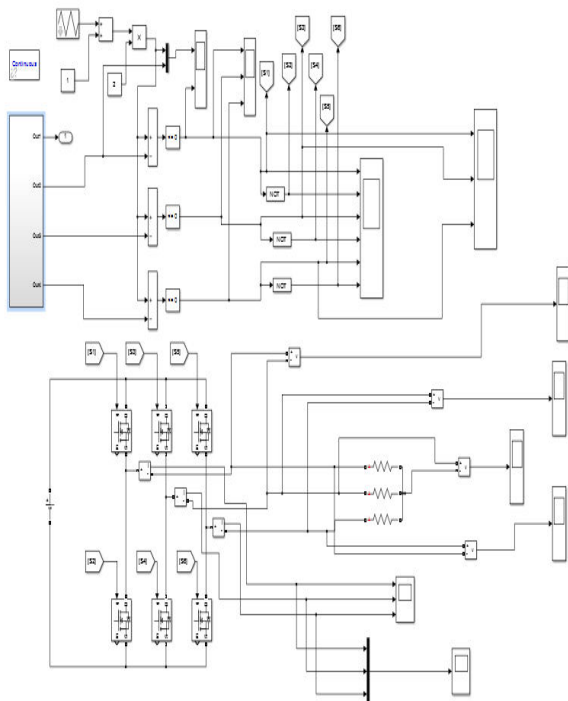

Fig - 11 Simulation diagram for the inverter.

SWITCHING REFERENCE WAVEFORM

Switching reference function represents the duty ratio of each inverter leg or the conduction time normalized to the sampling period for a given switch and it is a mathematical function with variation between 0 and 0.8 centred around 0.4.

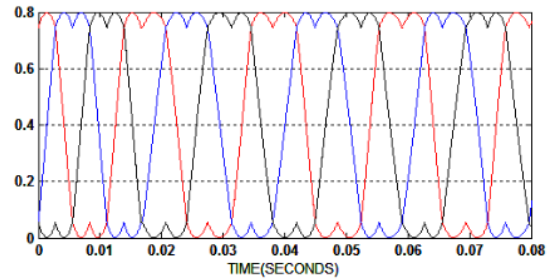

Figure 12 Switching Reference Waveform

SECTOR SELECTION OF VOLTAGE VECTOR

Sector corresponds to the location of voltage in the circular locus traced by the rotating reference vector of SVPWM inverter and is divided into six sectors of 60° each.

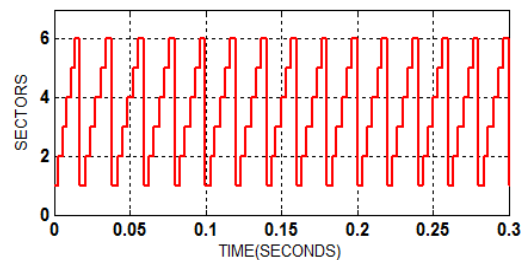

Fig - 13 Sector selection of voltage vector

OUTPUT LINE VOLTAGE

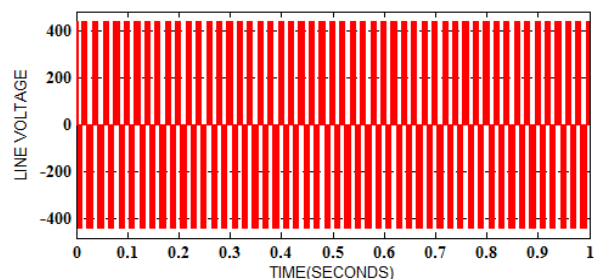
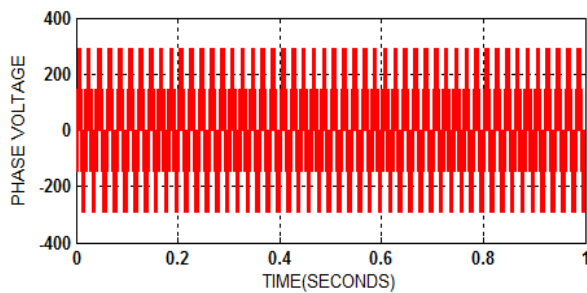

Fig - 14 output line voltage

## OUTPUT PHASE VOLTAGE



**Fig - 15 Output Phase Voltage**

## 6. CONCLUSIONS

Space vector Modulation Technique has become the most popular and important PWM technique for Three Phase Voltage Source Inverters for the control of AC Induction, Brushless DC, Switched Reluctance and Permanent Magnet Synchronous Motors. The Simulation study reveals that SVPWM gives fundamental output with better quality. The switching vectors for the inverter are derived using a simple digital logic which does not involve any complex computations and hence reduces the implementation time. SVPWM drive treats the inverter as a single unit with eight possible switching states, each state can be represented by a state vector in the two-axis space, the eight state vectors formed a hexagon shape with six sectors. The modulation procedure is accomplished by switching the state vectors in each sector by appropriate time intervals which are calculated in a certain sampling time ( $T_s$ ). The total losses of low order harmonics can be minimized by increasing the switching frequency, but in the other hand it may increase the switching losses, therefore, switching frequency must be selected to get minimum total harmonic and switching losses. The SVPWM is a digital modulating technique. Then from the above conclusion and due to simulation and experimental results, the SVPWM can be considered as the best and the optimum of all PWM technique.

## REFERENCES

1. S. Kouro, M. Malinowski, K. Gopakumar, J. Pou, L.G. Franquelo, B. Wu, J. Rodriguez, M.A. Perez and J.I. Leon, "Recent advances and industrial applications of multilevel converters", IEEE Trans. Ind. Electron. , vol. 57, no. 8, pp. 2553-2580, Aug. 2010.
2. A.R. Beig , "Synchronized SVPWM algorithm for over-modulation region of low switching frequency medium voltage three-level VSI", IEEE Trans. Ind. Electron., Early Access.

3. A.R. Beig , G. Narayanan and V. T. Ranganathan, "Modified SVPWM algorithm for three level VSI with synchronized and symmetrical waveforms", IEEE Trans. Ind. Electron., vol. 54, no. 1, pp. 486- 494, Feb. 2007.

4. S. Das and G. Narayanan, "Novel switching sequences for a space-vector modulated three-level inverter", IEEE Trans. Ind. Electron., vol. 59, no. 3, pp. 1477-1487, March 2012.

5. G. Narayanan and V.T. Ranganathan, "Two novel synchronized busclamping PWM strategies based on space vector approach for high power drives" , IEEE Trans. Power Electron., vol. 17, no. 1, pp. 84-93, Jan 2002.

6. L. Li, D. Czarkowski, Y. Liu, and P. Pillay, "Multilevel space vector PWM technique based on phase shift harmonic separation," in Proc. IEEE APEC, New Orleans, LA, Feb. 2000, pp. 535-541.

7. D. G. Holmes and T. A. Lipo, Pulse Width Modulation for Power Converters: Principles and Practice. Hoboken, NJ:Wiley, 2003.

8. S. Ogasawara, H. Akagi, and A. Nabae, "A novel PWM scheme of voltage source inverter based on space vector theory," in Proc. EPE, Aachen, Germany, Oct. 1989, pp. 1197-1202.

9. G. c, "Synchronised pulsewidth modulation strategies based on space vector approach for induction motor drives," Ph.D. dissertation, Indian Inst. Sci. , Bangalore, India, Aug. 1999.

10. V. G. Agelidis, A. Balouktsis, I. Balouktsis, and C. Cossar, "Multiple sets of solutions for harmonic elimination PWM bipolar waveforms: analysis and experimental verification", IEEE Trans. Power Electron. , vol. 21, no. 2, pp. 415-421, Mar. 2006.