

High Resolution Algorithm for Direction of Arrival Estimation

Nidhi Pathak

Department of Electronics & Comm. Engineering
Shri Ram Institute of Science & Technology
Jabalpur(M.P.)

Dr. J P Upadhyay

Department of Electronics & Comm. Engineering
Shri Ram Institute of Science & Technology
Jabalpur(M.P.)

Abstract— The requirement for Direction-of-Arrival (DOA) assessment emerges in many designing applications including remote correspondences, radar, radio space science, sonar, route, following of different items, salvage and other crisis help gadgets. In its cutting edge rendition, DOA assessment is normally examined as a component of the broader field of exhibit handling. A significant part of the work in this field, particularly in prior days, zeroed in on radio bearing finding that is, assessing the heading of electromagnetic waves impinging on at least one antenna

Keywords- Direction-of-Arrival (DOA), radar, radio space science, sonar, antenna.

I. INTRODUCTION

Signal processing aspects of smart antenna systems has concentrated on the development of efficient algorithms for Direction-of-Arrival (DOA) estimation and adaptive beam forming. The recent trends of adaptive beam forming drive the development of digital beam forming systems.

Signal preparing parts of smart antenna frameworks has focused on the improvement of proficient calculations for Direction-of-Arrival (DOA) assessment and adaptive beam forming. The new patterns of adaptive beam forming drive the advancement of computerized shaft framing frameworks.

Rather than utilizing a single antenna, an array antenna framework with inventive sign preparing can upgrade the goal of DOA assessment. An array sensor framework has numerous sensors conveyed in space. This array design gives spatial samplings of the got waveform. A sensor array has preferred execution over the single sensor in signal gathering and boundary assessment.

The minimum spacing between the neighboring antenna components in conventional thick arrays is normally restricted to half wavelength or less to stay away from spatial associating, which prompts significant mutual coupling and confined array aperture. As a rule, mutual coupling is naturally brought about by complex electro-magnetic interactions and is especially extreme for antenna sets with little partition. By and by, mutual coupling can bring about disastrous execution debasement in the assessment of fundamental framework boundaries, for example, complex channel gains and direction of appearance (DOA).

This implies that the course of action of the temporal spatial virtual array relies upon the speed and the bearing of the single objective on which we center. Subsequently, it is hard to carry out the technique in case there are a few focuses in the search space. There are different issues that still need to be settled. One is interference from different targets. Another is a mismatch between the steering vectors dependent on the pre-assessed target boundaries and the received signal. In this dissertation, to take care of these issues, we propose another DOA assessment technique by utilizing the temporal spatial virtual array dependent on yield signs of Doppler filter with adaptive pulse repetition interval (PRI) control. The proposed strategy gives exact DOA assessment by utilizing yield signs of Doppler filter with adaptive PRI control method. The presentation of the proposed technique is contrasted and that of the regular strategy through programmatic experiences with itemized execution investigation. The reenactment results show that the new DOA assessment technique performs better compared to the regular strategy.

II. DIRECTION OF ARRIVAL TECHNIQUES

A. Array Antenna :

The array antenna has been applied to different sorts of utilizations going from military use to business use, e.g., ground based radar frameworks and airborne radar frameworks, base stations for mobile communication and radio space science observatory, and so forth. Albeit the customary phased array antenna in Fig. (a) Gives just single blended signal at single perception, can acquire the advanced information of received signals at each element antenna independently by utilizing the adaptive array antenna as displayed in Fig.(b) and subjectively control the received gain

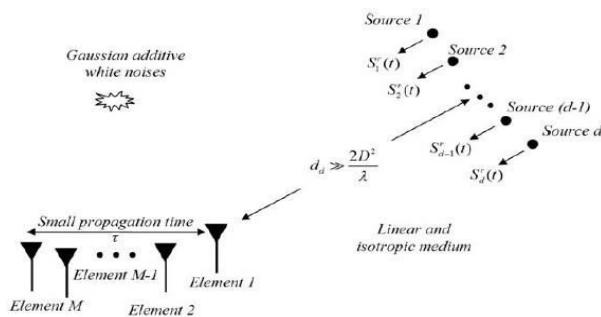

Figure 1: Overview of Direction-Of-Arrival Estimation

of the array antenna. Those are attributable to the improvement of RF gadgets and electric gadgets in ongoing year. In what follows, call the adaptive array antenna which can digitalize the received signal at each element antenna as just "array antenna".

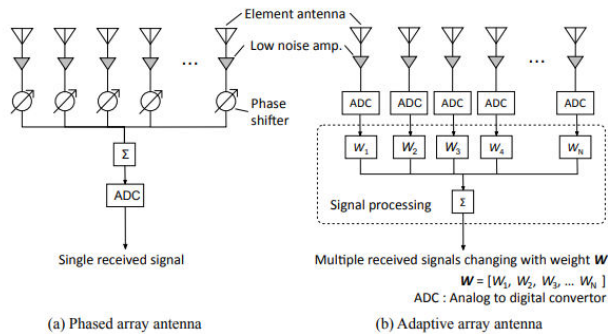

Figure 2: Phased and adaptive array

B. Array Configuration:

Array antenna performs spatial inspecting of approaching signal sources which are utilized to assess DOA of the signal sources as well as the quantity of signal sources. DOA assessment is one of the significant uses of the array antenna. The quantity of sources that can be settled relies upon the DOF of array antenna which is identified with exhibit setup. DOA assessment exactness with array antenna additionally relies upon the cluster arrangement. Along these lines, comprehend the essential connection between array arrangement and DOA assessment execution. This part, demonstrate the array arrangements to be utilized.

C. Subspace Technique:

a) *MUSIC*-MUSIC represents Multiple Signal Classification. It is one of the soonest proposed and an exceptionally well known technique for super-resolution direction discovering, which gives the assessment of number of signals arrived, subsequently their direction of arrival. MUSIC is a method dependent on taking advantage of the Eigen design of input covariance matrix. Eigen vectors are effectively obtained by either an Eigen decomposition of test covariance matrix or a Singular Value Decomposition (SVD) of the information framework. In, the creators demonstrate that one needs essentially

b) *ESPRIT*- ESPRIT is like MUSIC in that it takes advantage of the hidden information model and produces estimates that are asymptotically fair and proficient. Also, it enjoys a few significant upper hands over MUSIC.

The ESPRIT method for DOA assessment represents Estimation of Signal Parameter via Rotational Invariance Technique. This calculation is heartier concerning cluster flaws than MUSIC. Calculation intricacy and capacity

prerequisites are lower than MUSIC as it doesn't include extensive search all through all conceivable guiding vectors. Be that as it may, it investigates the rotational invariance property in the signal subspace made by two sub exhibits got from unique cluster with an interpretation invariance structure. Not at all like MUSIC, ESPRIT doesn't need that array complex vectors be unequivocally known, subsequently the exhibit adjustment prerequisites are not tough disintegrated into two equivalent measured indistinguishable sub array with the comparing components of the two sub arrays dislodged from one another by a fixed translational (not rotational) distance.

III. PROPOSED ALGORITHM

A. Signal Model :

Advanced Multiple Signal Classification (A-MUSIC) is a high-resolution direction search algorithm dependent on the eigen value deterioration of the sensor covariance matrix observed at a array.

In case there are D signals incident on the array, the obtained input information vector at a M-element array can be represented as a D linear combination of the occurrence waveforms and noise. That is,

$$u(t) = \sum_{i=0}^{D-1} \alpha(\theta_i) s_i(t) + n(t)$$

$$u(t) = [\alpha(\theta_0) \ \alpha(\theta_1) \ \dots \ \alpha(\theta_{D-1})] A s(t) + n(t)$$

$$\begin{bmatrix} s_0(t) \\ s_1(t) \\ \vdots \\ s_{D-1}(t) \end{bmatrix} = n(t)$$

From equation, it is seen that the received vector is a particular linear combination of the array steering vectors, α with α being the coefficients of the combination. In terms of the above data model, the input covariance matrix R_{uu} can be expressed as,

$$R_{uu} = E[uu^H] + AE[ss^H]A^H + E[nn^H]$$

where R_{ss} is the signal correlation matrix $E[nn^H]$.

The Eigen values of R_{uu} are the values,

$$\{\lambda_0, \dots, \dots, \lambda_{M-1}\}$$

Such that $|R_{uu} - \lambda_i I| = 0$

B. Advanced Music Algorithms

Under the reason of an exact model, MUSIC calculation can hypothetically accomplish a subjectively high goal to DOA. Nonetheless, for MUSIC calculation signals, it is restricted to uncorrelated signs. At the point when the source is a connected sign or a sign with low SNR, the assessed execution of the MUSIC calculation weakens or even totally loses. This segment gives a concise prologue to a further developed MUSIC calculation, which is proposed by form

reproduction of the information framework of the MUSIC calculation.

C. RMSE Calculation:

RMSE of the signal source is calculated by the following equation.

$$RMSE_{\theta_t} = \sqrt{\frac{1}{T} \sum_{t=1}^T (\hat{\theta}_{1,t} - \theta_t)^2}$$

Where T is the number of simulation runs and θ_t denotes the true direction of the signal source, and $\hat{\theta}_{1,t}$ denotes the estimated one of the t th simulation run, which is the direction of the nearest peak to the true direction. Even if we detect less signals than the actual number of signal sources, we use the nearest direction as the estimated one. This means that the calculations to obtain the RMSE of closely spaced signals use the same direction when they cannot be resolved each other.

IV. RESULTS AND DISCUSSION

Four wideband signal sources are considered to observe and demonstrate the DOA estimation accuracy and resolution performance of the proposed method. Following parameters are used: 100 iteration runs for performance of each algorithm. Here M- number of antennas, L- signal sources, K- frequency bands, λ - wavelength corresponding to the highest frequency component of the received wideband signals.

Figure 3, 4, 5 and 6 shows the spatial spectrum of proposed method, where SNR of each incoming signal source is 15, 20, 25 & 30 dB are considered for four cases i.e. M = 10, K = 15 and 75 , and L = 3 (for -15 deg., 0 deg., and 15 deg.); M = 10, K = 20 and 60 , and L = 3 (-20 deg., 0 deg., and 20deg.); M = 10, K = 20 and 80 , and L = 3 (-25 deg., 0 deg., and 25 deg.); M = 10, K = 15 and 80 , and L = 3 (-30 deg., 0 deg., and 30 deg.) The normalized inverse of the smallest singular value shows that each spectrum has some sharp peaks at the true directions, which indicated as dotted lines in the figure.

Figure 6 show root mean square errors (RMSE) of the estimated DOA of the signal sources 1 and 2, respectively.

From these figures, it is found that the proposed method yields the better performance of DOA estimation accuracy for closely spaced wideband signal sources than those of Squared TOPS, TOPS, and IMUSIC. It is also found that the DOA estimation accuracy of the proposed method deteriorates compared to that of WS-TOPS, because the proposed method only uses two frequency bands to reduce the computational complexity. The simulation results prove that the proposed method can achieve good performance of DOA estimation compared to those of other conventional methods with low computational complexity.

Figure3 : Spatial spectrum on (a) M = 10, K = 15 and 75 , and L = 3 (-15 deg., 0 deg., and 15 deg.)

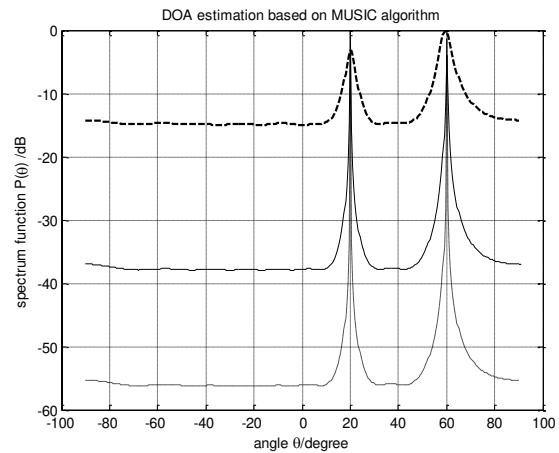

Figure 4: Spatial spectrum on (a) M = 10, K = 20 and 60 , and L = 3 (-20 deg., 0 deg., and 20deg.)

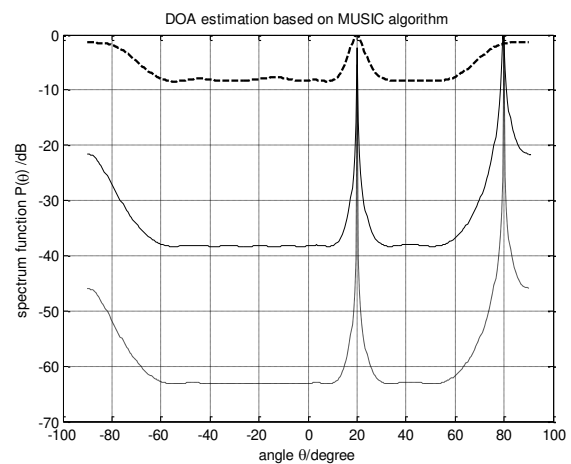
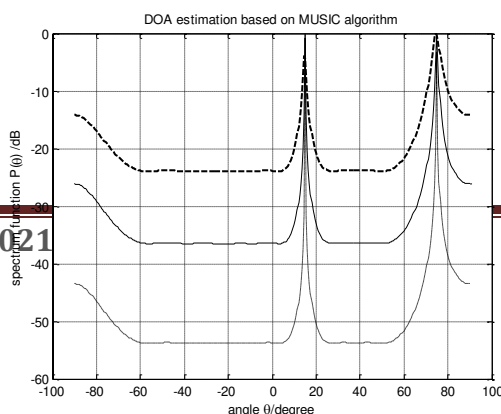

Figure5 : Spatial spectrum on (a) M = 10, K = 20 and 80 , and L = 3 (-25 deg., 0 deg., and 25 deg.)



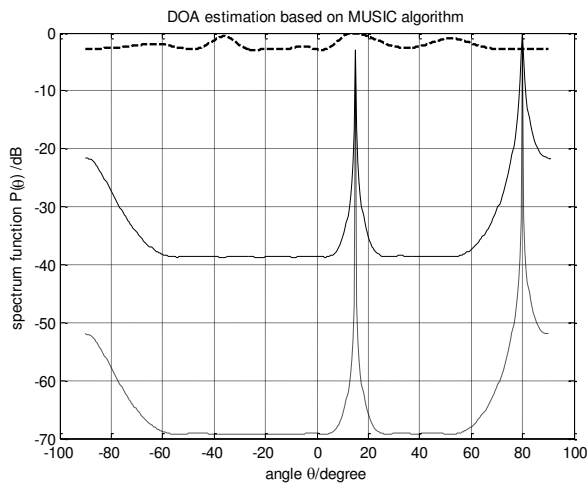

Figure 6: Spatial spectrum on (a) $M = 10$, $K = 15$ and 80 , and $L = 3$ (-30 deg., 0 deg., and 30 deg.)

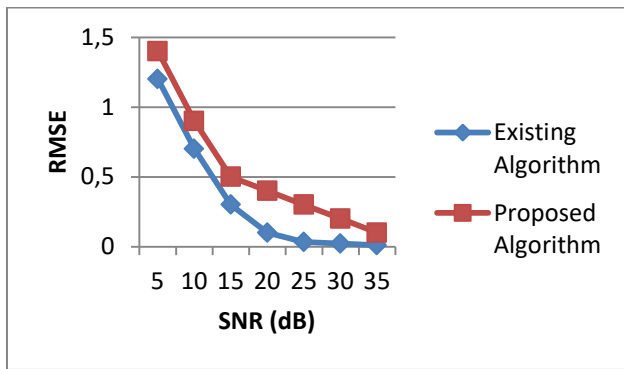

Figure 7: RMSE V/S SNR for existing and Proposed Algorithm

V. CONCLUSIONS

A novel direction of arrival estimation algorithm has been developed. The proposed algorithm outperforms conventional methods both in terms of its performance as well as computational requirements. In the proposed algorithm, two equivalent covariance matrices are reconstructed to achieve the decorrelation of the coherent signals and the estimated angle parameters are pair-matched automatically.

A future exertion might inspect techniques to diminish the effect of those mistakes. This proposition accepted fixed sources and clusters. This supposition can be reached out to incorporate stages that are moving at low paces. A future exertion could likewise look at the exhibition of the proposed conspire in following applications. A sign force limit was utilized to guarantee that all reflections are "single ricochet." Future work might take care of the affiliation issue of numerous bounce reflections and take advantage of the data contained in those reflections. At long

last, an investigation which analyzes the computational expense of both the brought together and the conveyed designs of the proposed confinement plan might be a subject for a future work.

REFERENCES

- [1] S. Adavanne, A. Politis, J. Nikunen, and T. Virtanen, (2019), Sound event localization and detection of overlapping sources using convolutional recurrent neural networks, *IEEE Journal of Selected Topics in Signal Processing*, vol. 13, no. 1, pp. 34–48.
- [2] L. Perotin, R. Serizel, E. Vincent, and A. Gu'erin, (2018), Crmn-based joint azimuth and elevation localization with the ambisonics intensity vector, in *Proc. Intl. Workshop Acoust. Echo Noise Control (IWAENC)*, Tokyo, Japan.
- [3] S. Adavanne, A. Politis, and T. Virtanen, (2018), Direction of arrival estimation for multiple sound sources using convolutional recurrent neural network, in *Proc. European Signal Processing Conf. (EUSIPCO)*.
- [4] W. He, P. Motlicek, and J. Odobez, (2018), Deep neural networks for multiple speaker detection and localization, in *IEEE International Conference on Robotics and Automation (ICRA)*, pp.74–79.
- [5] N. Ma, T. May, and G. J. Brown, (2017), Exploiting deep neural networks and head movements for robust binaural localization of multiple sources in reverberant environments, *IEEE Trans. Audio, Speech, Lang. Process.*, vol. 25, no. 12, pp. 2444–2453.
- [6] N. Yalta, K. Nakadai, and T. Ogata, (2017), Sound source localization using deep learning models, *Journal of Robotics and Mechatronics*, vol. 29, pp. 37–48.
- [7] F. Vesperini, P. Vecchiotti, E. Principi, S. Squartini, and F. Piazza, (2016), A neural network based algorithm for speaker localization in a multi-room environment, *IEEE 26th International Workshop on Machine Learning for Signal Processing (MLSP)*, pp. 1–6
- [8] R. Takeda and K. Komatani, (2016), Sound source localization based on deep neural networks with directional activate function exploiting phase information, in *Proc. IEEE Intl. Conf. on Acoustics, Speech and Signal Processing (ICASSP)*, pp. 405–409.
- [9] R. Takeda and K. Komatani, (2016), Discriminative multiple sound source localization based on deep neural networks using independent location model, in *IEEE Spoken Language Technology Workshop (SLT)*, pp. 603–609.
- [10] Kaiming He, Xiangyu Zhang, Shaoqing Ren, and Jian Sun, (2016), Deep residual learning for image recognition, *IEEE Conference on Computer Vision and Pattern Recognition (CVPR)*, pp. 770–778.
- [11] M. Parchami, W. Zhu, B. Champagne, and E. Plourde, (2016), Recent developments in speech enhancement in the short-time fourier transform domain, *IEEE Circuits and Systems Magazine*, vol. 16, no. 3, pp. 45–77.
- [12] T. Hirvonen et al., (2015), Classification of spatial audio location and content using convolutional neural networks, in *138th Audio Engineering Society Convention*, vol. 2. Bibliography 129
- [13] X. Xiao, S. Zhao, X. Zhong, D. L. Jones, E. S. Chng, and H. Li, (2015), A learning-based approach to direction of arrival estimation in noisy and reverberant environments, in *Proc. IEEE Intl. Conf. on Acoustics, Speech and Signal Processing (ICASSP)*, pp. 2814–2818.
- [14] Yan Huang, M. Slaney, Y. Gong, and M. Seltzer, (2014), Towards better performance with heterogeneous training data in acoustic modeling using deep neural networks, in *Proc. Interspeech Conf. , ISCA - International Speech Communication Association*.
- [15] O. Thiergart, M. Taseska, and E.A.P. Habets, (2014), An informed parametric spatial filter based on instantaneous direction-of-arrival estimates, *IEEE Trans. Acoust., Speech, Signal Process.*, vol. 22, no. 12, pp. 2182–2196.

- [16] S. Malik, J. Benesty, and J. Chen, (2014), A Bayesian framework for blind adaptive beamforming, *IEEE Trans. Signal Process.*, vol. 62, no. 9, pp. 2370–2384.
- [17] Chun-Yang Chen and P.P. Vaidyanathan, (2007), Quadratically constrained beamforming robust against direction-of-arrival mismatch, *IEEE Trans. Signal Process.*, vol. 55, no. 8, pp. 4139–4150.
- [18] C.J. Lam and AC. Singer, (2006), Bayesian beamforming for DOA uncertainty: Theory and implementation,” *IEEE Trans. Signal Process.*, vol. 54, no. 11, pp. 4435–4445.
- [19] I. Cohen et.al., (2004), Relative transfer function identification using speech signals,” *IEEE Trans. Acoust., Speech, Signal Process.*, vol. 12, no. 5, pp. 451–459.
- [20] O. Besson, AA Monakov, and C. Chalus, (2004), Signal waveform estimation in the presence of uncertainties about the steering vector, *IEEE Trans. Signal Process.*, vol. 52, no. 9, pp. 2432–2440.
- [21] K.L. Bell, Y. Ephraim, and H.L. Van Trees, (2000), A Bayesian approach to robust adaptive beamforming,” *IEEE Trans. Signal Process.*, vol. 48, no. 2, pp. 386–39.
- [22] J. Yang and A. L. Swindlehurst, (1995), The effects of array calibration errors on df-based signal copy performance, *IEEE Trans. Signal Process.*, vol. 43, no. 11, pp. 2724–2732.
- [23] M. H. Er and B. C. Ng, (1994), A new approach to robust beamforming in the presence of steering vector errors, *IEEE Trans. Signal Process.*, vol. 42, no. 7, pp. 1826–1829.
- [24] B.D. Van Veen, (1991), Minimum variance beamforming with soft response constraints, *IEEE Trans. Signal Process.*, vol. 39, no. 9, pp. 1964–1972.
- [25] B. Friedlander and B. Porat, (1989), Performance analysis of a null-steering algorithm based on direction of-arrival estimation, *IEEE Trans. Audio, Speech, Lang. Process.*, vol. 37, no. 4, pp. 461–466.
- [26] H. Cox, R. M. Zeskind, and M. M. Owen, (1987), Robust adaptive beamforming, *IEEE Trans. Acoust., Speech, Signal Process.*, vol. 35, no. 10, pp. 1365–1376.