

RFID BASED PREPAID ENERGY METER

K.Mahesh Babu , Asna Faiz, K. Sushmitha, G. Lakshmi Priya, K.Navneetha

Department of Electronics and Communication Engineering

BVRIT HYDERABAD College of Engineering for Women, Hyderabad, Telangana, India

Abstract—The electrical power meter plays an important role in energy consumption. In the past, many consumers have faced issues with the inaccurate reading of the energy meter. This paper presents Smart Energy Meter where users can monitor their power consumption (bill) anytime from anywhere by using their mobile phone via Short Message Services (SMS). It consists the development of the electrical power meter equipped with RFID reader. When the reader reads a valid RFID card the power meter is activated so that it can supply electricity. When the credit has reached the low limit an SMS message will be sent to the user's hand phone to alert. It would be a huge benefit for the customers if they can monitor their energy meter's power consumption (bill) on a real-time basis.

KEYWORDS: Arduino Uno, Energy meter, RFID module, GSM module.

1. INTRODUCTION

Prepaid electrical power meter may not be popular in some areas though it has been used in many applications. It is designed for customers who have to control their power consumption. In addition, an individual can use electricity, based on the bill.

This paper focuses on developing a prototype of the prepaid energy meter employing RFID technology. In the current RFID prepaid energy meters, many have used various "read" types which helps in activating the meter and supplying electricity to the consumers. RFID card can be credited only with a particular code, where it cannot be changed.

Therefore one should use different RFID cards to top up different credits in the RFID card. There exists another type of RFID card where it does both reading and writing the data. This kind of RFID card needs a special RFID reader to operate.

The RFID reader can be connected through USB cable to the computer. When the RFID card placed on the reader,

the data can be transferred to the mobile or from the mobile to the RFID card. For convenient use of RFID prepaid power meter, the reading and writing type of RFID device is chosen.

This kind of RFID device helps in reducing the number of RFID cards used for different credits top up. One card can be credited with different amounts of credit by programming.

2. LITERATURE SURVEY

Here we are focusing on the development of a system being used to read energy meter reading and provide users with the availability to check their current credit and consumed units.

The present power usage read manually by consumers moving to different locations [2]. This requires large number of labour operators and long working hours to complete the specific task. Manual billing is sometimes restricted due to bad weather conditions.

Previously, Smart Energy Meter has been proposed as an ingenious solution targeted at facilitating affordability and reducing the cost of utilities. This mechanism mostly, requires the users to pay for the electricity before it's consumption[4]. This way, consumers save credit and then use the electricity until the credit is exhausted.

If the available credit is completely used then the electricity supply is cut off by a relay. Readings made by humans can cause errors. This paper addresses the above mentioned problems[6]. The development of GSM module have made meter reading systems wireless.

The GSM infrastructure, is used to request and retrieve power consumption notification for individual houses and flats[7].

3. IMPLEMENTATION

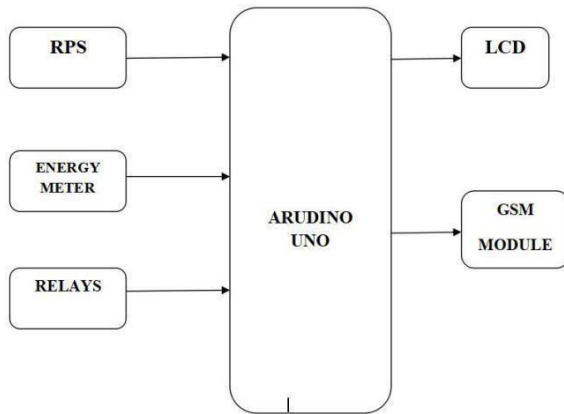

When the correct RFID card is read by the RFID Reader module, the data present in the card is transferred to the microcontroller. It will generate the power and it triggers the relay so that AC Load is connected to AC Source. With this the credits will be displayed on the LCD Screen.

As the credit is low the buzzer will be activated and SMS will be sent to the registered mobile number. It will send the SMS using the GSMModule.

4. RELATED WORK

ARDUINO UNO:

Arduino uno is a microcontroller board. It is based on ATmega 28. It has 14 digital pins. It also has a crystal oscillator which is of 16MHz. It is also provided with USB connection. We can power it using AC - DC Adapter or battery.



ENERGY METER:

It is the meter which is used to measure the consumed power by any household equipments. It contains aluminium discs whose rotations will convey how much amount of energy is used or consumed.



RFID MODULE:

Radio Frequency Identification system consists of two main components, a transponder/transmitter attached with an object to be identified, and a Trans-receiver also known as interrogator/receiver. It consists of a Radio Frequency module and an antenna which generates high frequency electromagnetic field. It can read until the range of 5 cm.

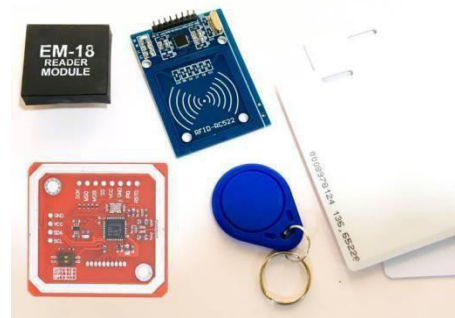

GSM MODULE:

A GSM module is a chip that is used to establish communication between a mobile device or a computer and a GSM system. The modem (modulator-demodulator) plays the critical part. These modules consist of a GSM module energized by a power supply circuit and communication interfaces (like RS-232, USB 2.0, and others) for computer. A GSM modem can be a dedicated with a serial USB or Bluetooth connection, or a mobile phone which provides GSM modem capabilities.



LDR:

The Sensor Module detects the presence of light which is used in measuring the intensity of light. The output of the module turns on in the presence of light and gets turns off in the absence of light. The sensitivity of the signal detection can be adjusted with the help of potentiometer.

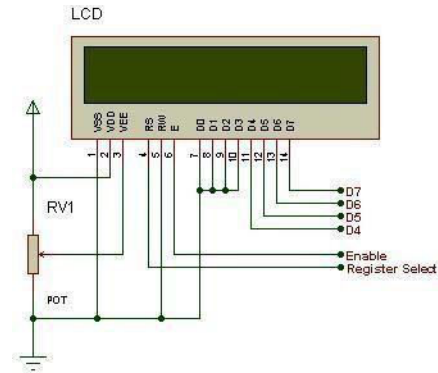
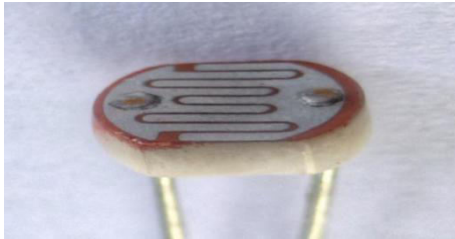

5. CONCLUSION

In this paper, we have seen the operation of RFID based energy meter by using Arduino UNO as microcontroller and GSM module as interface.

This provides the users to monitor their current bill or power consumptions usage from anywhere with their mobile phones. When the credit is about to finish, the RFID power meter will alert the users via GSM hand phone.

This system can be used by the electrical power utility company and consumers for alternatives in electrical billings.

CRYSTAL OSCILLATOR:

Crystal oscillators have a mechanically resonant and piezoelectric circuit element in the feedback loop of amplifying device. This element is usually a quartz crystal. The piezoelectric material to create an electric signal with a constant frequency. The frequency is often used to keep track of time , as in quartz wristwatches, providing a stable clock signal for digital integrated circuits, and to stabilize frequencies for radio transmitters and receivers.



6. RESULTS

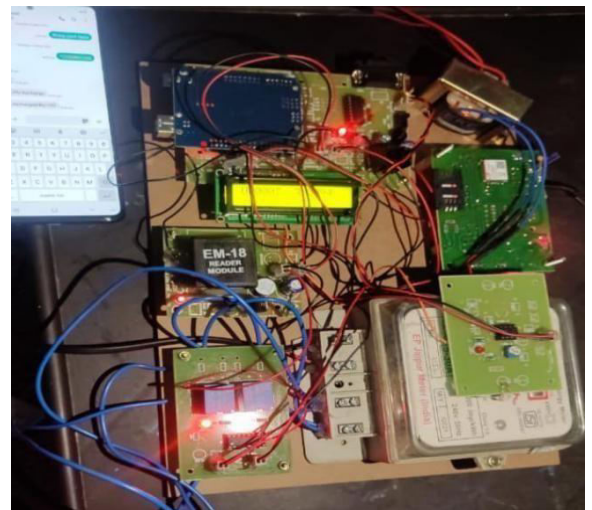

Fig 1: Hardware Kit

LCD DISPLAY:

Liquid-crystal display (LCD) is a flat-panel display modulated optical device that uses the light-modulating properties of liquid crystals in combination with polarizers. They do not emit light directly, they use a backlight or reflector for producing image in color or monochrome.

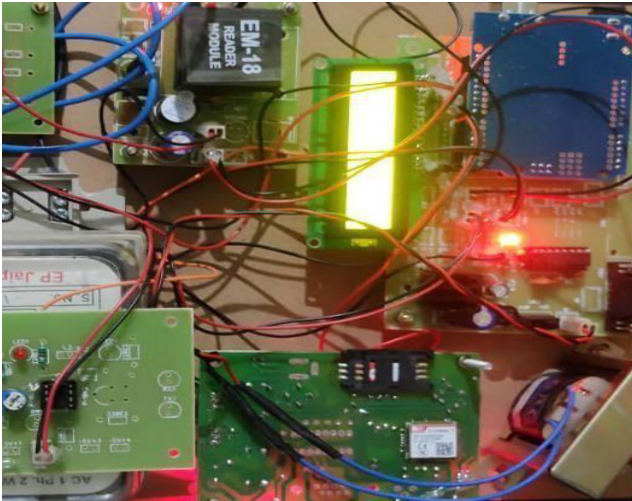

Fig 2: Interfacing of Wifi Module

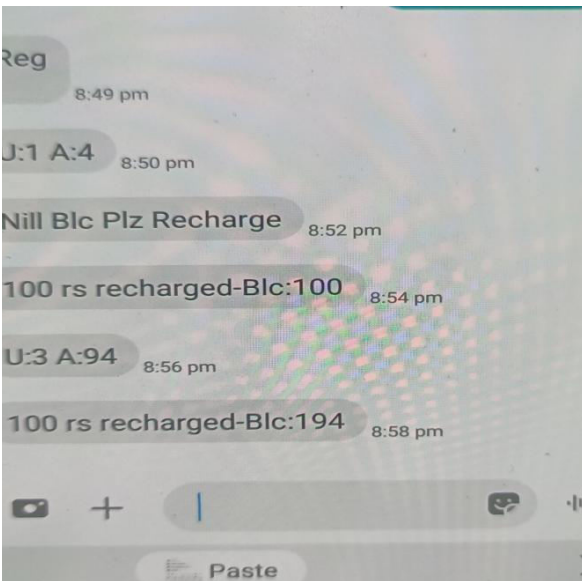

Fig 3: Sending SMS to registered mobile number



Fig 4:Units and Cost Display

7. FUTURE WORK

This work can be taken forward by controlling the energy meter, instead of just monitoring the meter power consumption, controlling the home appliances will be one step further, so that the users can even control their bill usage power consumptions by themselves remotely from their mobile phones.

8. REFERENCES

- [1].https://www.researchgate.net/publication/286746395_RFID-based_prepaid_power_meter
- [2].<https://ieeexplore.ieee.org/document/8082078?denied>
- [3].www.electronicshub.com
- [4].S Ezhilarasu, K Riju, K Venkatesh, M Varatharaj;, An Enhancment of Prepaid Energy Meter Using Smart Card And GSM Module Techniques International Journal of Research in Electronics , vol.2 , Issue 3, March 2015.
- [5].Jignesh Somabhai Prajapati,Ashwin P Patel,Vyom M Bhankhariya;, Prepaid Electricity Billing System Journal Of Information, Knowledge And Research In Electronics And Communication Engineering , vol.2, Issue 2, October 2013.
- [6].Sudarshan K Valluru;,Design and Assembly of Low Cost Prepaid Smart Card Energy Meter-A Novel Design, International Journal on Electrical Engineering and Informatics , vol.23, 2013.
- [7].Nabil Mohammad, Anomadarsini Barua and Muhammad Abdullah Arafat;,A Smart Prepaid Energy Metering System to control Electricity Theft, International Conference on Power, Energy and Control , vol.13, 2011.