

Analysis and Design of R.C.C T-Beam Bridge Superstructure by using Different Codes & Load Combination for Performance Assessment

¹ Prof. Girish Sawai, ²Tanmay Farsule

¹Head of Dept. of Civil engineering, VM Institute of Engineering and Technology, Nagpur, Maharashtra, India

²Research Scholar, Dept. of Civil engineering, VM Institute of Engineering and Technology, Nagpur, Maharashtra, India.

Abstract: This study summarized comparative design and analysis of RCC T-Beam Bridge superstructure for Different Codes i.e., Indian Road Congress (IRC) codes and American Association of State Highway Transportation Officials (AASHTO) Specification Load Combinations for varying span length. The several codes are used to design the bridges. IRC 21-2000 used for designing bridges by working stress method (WSM), also IRC: 112-2011 introduced by Indian Road Congress for RCC and Pre- Stressed bridges by limit state method (LSM). Both the codes have different guidelines and procedure for design of bridges. This study based on IRC 112-2011 (LSM) and IRC: 6- 2017 is used for load considerations. In which this analysis depends on the analytical modelling by Finite Element Method (FEM) for in STAAD-Pro software and comparing the structural parameter Bending moment, Shear Force, Deflection and Area of Reinforcement for different girder span length 16M, 20M, 24M as per the IRC and AASHTO code. Class A & Class 70R consider from IRC 6-2017 and HS93 is the vehicular loading consider from AASHTO. Form the analysis understanding suitability design technique and the behavior of two-lane carriage way width of T-Beam bridge superstructure under different loading condition and by using different code and comparing the result, conclusions will be made that up to what extents similarities between both standards.

Keywords: IRC: 21-2000, IRC: 112-2011, AASHTO (LRFD), STAAD-Pro.

1. INTRODUCTION

Bridges are the life line of road network and provide escape from difficult location, both in urban and country zones. It is a structure providing transit over an obstacle without closing the way underneath. This may be required for a road transport, a railway transport, pedestrians, a canal, or a pipeline. Among many kinds of bridges, Beam Bridge is significant to allow vehicle or pedestrian traffic to cross over a road, railway or valley and waterway like river for transportation. Beam bridges are classified into many types based on shape of cross section I-Beam, T- Beam, Box girder.

Bridge design methods or practices differ throughout the world widely. In India Engineers have been using IRC 21-2000 for designing bridges which is based on working stress method (WSM), also IRC:112-2011 introduced by Indian Road Congress for RCC and Pre-Stressed bridges which is based on limit state method (LSM). Both the codes have different guidelines and procedure for design of bridges. In limit stress method, it has been observed that 20 is the most preferable length and depth ratio in limit state method. 30 to 35% reduction in cost of concrete is possible using limit state method. In our country for load consideration IRC: 6:2017 standards are referred for designing bridge while in United States, load considerations are inbuilt in the AASHTO code only.

This study is performed on two lane carriage way width RCC T-beam Bridge shown in (fig. No. 1) of span 16m, 20m, 24m. The bridge span is designed by using IRC: 112-2011 codes and analysed by using STAAD Pro. The results are compared with the results of same span of RCC-T Beam Bridge superstructure by AASHTO. IRC6:2017 is used for load and load combination.

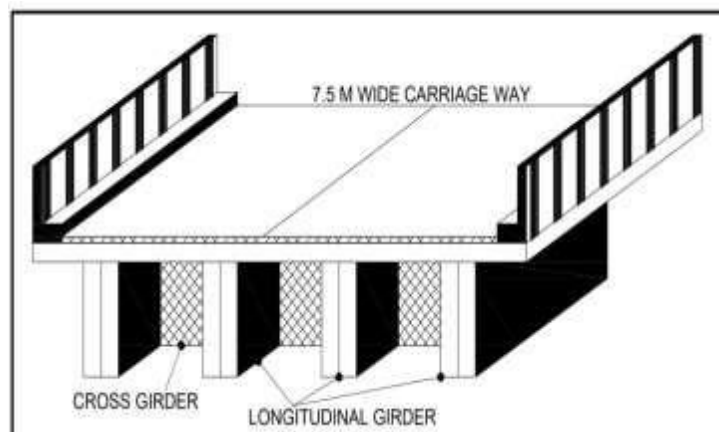

FIG1. TYPICAL SECTION OF T- BEAM BRIDGE

2. LOAD CONSIDERRATION.

2.1 DEAD LOAD (D.L.)

2.1.1 IRC DEAD LOAD (CLAUSE NO.203 IRC 6-2017)

The dead load is the intrinsic weight or constant load which carried by a structural member and supported entirely or in part by the same member of structure including its self-weight. In ordered to determine dead load (D.L.) of members unit weights of materials are provided in the IRC code. Following unit weights shall be used.

Material	Weight (T/m3)
Concrete (asphalt)	2.2 T/m3
Concrete (Plain- cement)	2.5 T/m3
Concrete (Cement-Reinforced)	2.5 T/m3

2.1.2 IRC SUPER IMPOSED DEAD LOAD (S.I.D.L.)

The Superimposed Dead Load (SIDL) which consist of dead gravity loading due to other permanent non-structural parts of bridge such as anti-crash barriers, floor finishes and other services. Such item is long term but might be changed during the lifetime of the structure. Similar to self-weight it is calculated as the product of volume and density of material.

Most remarkable item in super imposed load is road pavement, surfacing and ACB and over the period of time road pavement to get progressively thicker as each new layer of surfacing simply laid over the before thus SIDL is prone to increase during the life of bridge. For this reason, a high load factor is applied to SIDL items. So, Bridges are uncommon among structures and high portion of total loading hold responsible to dead load and superimposed dead load.

2.1.3 AASHTO DEAD LOAD (CLAUSE 3.5.1)

AASHTO Dead load shall include the weight of all components of the structure and utilities attached thereto, earth cover, wearing surface, future overlays, crash barriers, kerbs and planned widening. In the absence of more precise information, the unit weights specified below, can be used for calculating dead loads.

Concrete (Normal Weight with $5.0 < f'c \leq 15.0$ ksi) - $0.140 + 0.001 f'c$

2.2 LIVE LOAD (L.L.)

2.2.1 IRC LIVE LOAD (IRC: 6–2017 CLAUSE 204.1)

This loading is to be normally used for all roadways on which permanent structure are being constructed. The structure which are constructed on permanent basis like bridges, Culvert etc. Particularly wheeled live loading IRC Class A & Class 70R is used specified in (Fig 2&3). In IRC it is stated that while designing bridges for Class A Loading it may give heavier stresses in certain condition because of that Class 70R loading should also be cross verify for Class A.

The carriage way Live load combination for design as per clause no. 204.3 IRC 6-2017

S.N.	Carriage way width	Number of Lane	Live Load Combination
1	CW < 5.3M	1 Lane	Class A one Lane to occupy 2.3m
2	5.3m < CW > 9.6m	2 Lane	70R One Lane or Class A two Lane
3	9.6m < CW > 13.1m	2 Lane	70R One Lane or Class A two Lane

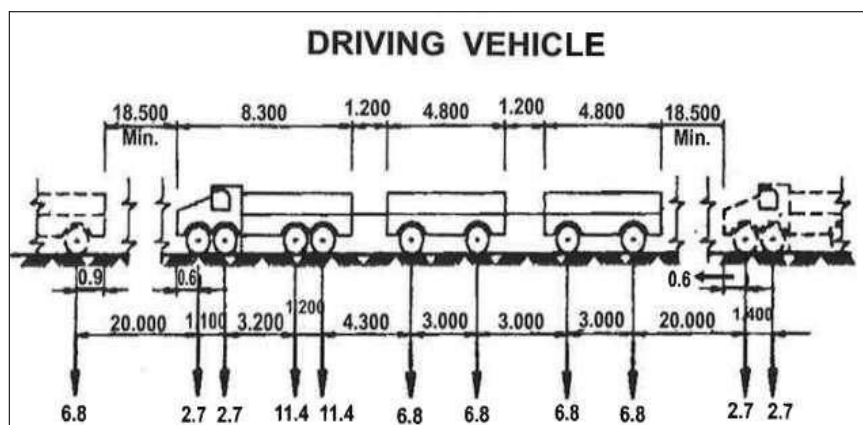

FIG2. CLASS A WHEELED LOAD

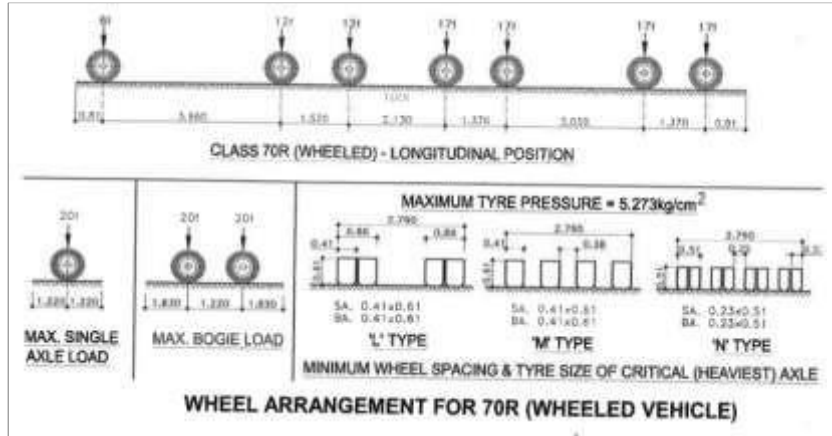

FIG 3. 70R WHEELED LOAD

2.2.2 AASHTO LIVE LOAD (L.L.) – CLAUSE 3.6.1.2

Live Load (L.L.), HL93-44 is the vehicular loading used by AASHTO. It is used in USA for design loading of bridges and used in countries where AASHTO code is followed. This is a hypothetical Live Load HL-93 Model proposed by AASHTO for analysis of bridges. Reason for producing such type of live load to generate maximum stresses on structure. It has three basic live load for bridges called HL93 which includes different types of vehicular or moving loads Such as Design Truck, Design Tandem and Design Lane Loading.

Placement of HL93 Load

1. HL93 Truck + Design Lane
2. Design Tandem + Design lane

It should be placed in such way that extreme force shall be obtained for design (Maximum of Two).

A. DESIGN TRUCK

Design Truck consists of three axles, front axle weighing 35 KN (8 kip) or 4 Ton and two rear axles weighing 145 KN (32kip) or 16 Ton. The distance between front and rear axle is 4.3m (14') and that of two rear axles can be varied between 4.3m (14') to 9.0m (30') in order to induce a maximum positive moment in a span. The tyre-to-tyre distance in any axle is 1.8m (6'). Design Truck also called as HS20-44 vehicle where H stands for highway, S for semitrailer, of 20-ton (325 KN) weight of the tractor with powerful, lager wheel vehicle and was proposed in 1994. The Weights and spacing's of axles and wheels for the design truck shall be specified in (Fig. 4). A dynamic allowance or impact factor shall be considered.

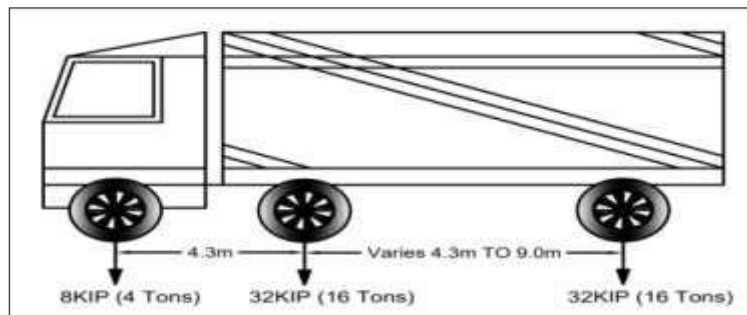

FIG 4. HS20-44 DESIGN TRUCK

B. DESIGN TANDEM

It consists of two axles weighing 12 Tons (110KN) each spaced at 1.2 meter as shown in (Fig no 5). This has been used to obtain maximum negative moments. Maximum number of tandems and minimum desistance between tandems not specified in code that can be consider in lane.

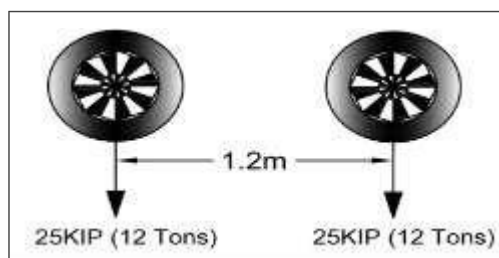

FIG. No.5

C. DESIGN LANE LOAD

The design lane load shall consist of a load of 9.3KN/M (0.64 klf) uniformly distributed in the longitudinal direction shown in (fig.no.6) Transversely, the design lane load shall be assumed to be uniformly distributed over a 3 m (10 ft) width. A dynamic load allowance shall not be applied to the force impacts of design lane load. The force effects from design lane load shall not be subjecto a dynamic load allowance.

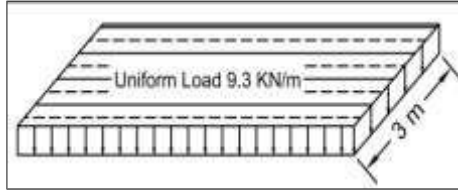

FIG No.6

In AASHTO, there are not such combinations of live load as specified in IRC code for different design vehicle, because, In AASHTO, there is one design truck HL93, which has to run for all numbers of lanes for design purpose.

2.3 IMPACT LOAD

2.3.1 IRC IMPACT LOAD (IRC 6-2017 CLAUSE 208.2)

A. IRC 6-2017 CLAUSE NO 208.2 for Class A or class B Loading The impact percentage fraction shall be determined from the following equations which are applicable for spans between 3 m and 45 m, for beyond 45 m refer (fig no.7)

$$\text{FOR RCC BRIDGES} = \frac{4.5}{6 + L}$$

B. IRC 6-2017 CLAUSE NO 208.3 for Class AA or class 70R wheeled loading. The impact percentage fraction shall be determined from the following equations.

For wheeled vehicles

- a. Span length (L<9m) Impact percentage shall be taken as 25 %
- b. Span length (L>9m or equal)
 - For RCC bridges 25% for span upto 12M and span in excess

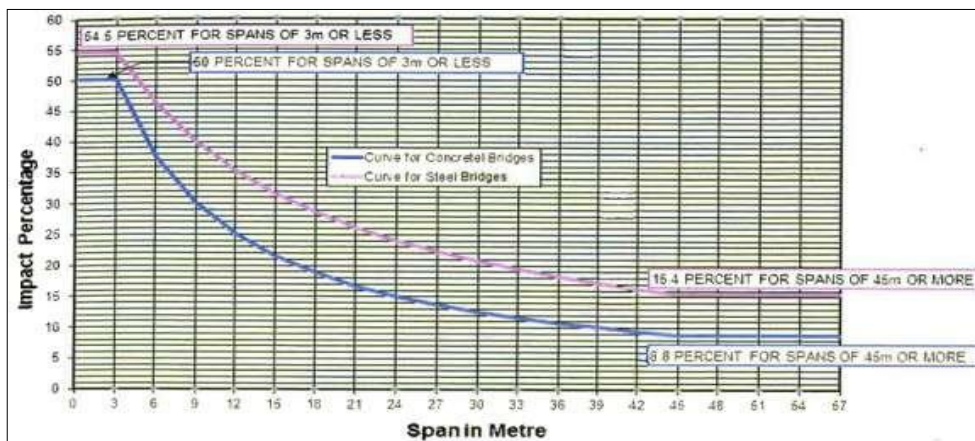

FIG NO.7

2.3.1 AASHTO IMPACT LOAD

In the AASHTO Standard Specifications in the United States, the impact factor due to bridge vibration for members in Group A including superstructure, piers and those portion above the ground that support the superstructure, is simply described as a function of bridge span:

$$IM = \frac{50}{L + 125} \leq 0.30$$

Where L (in ft) is the length of span loaded to generate maximum stress.

In the AASHTO LRFD Bridge Design Specifications (1994), the static effects of the design truck or tandem shall be increased by 33% the impact effect.

1. LOAD COMBINATIONS

1.1 IRC LOAD COMBINATION

(IRC: 6-2017) – Annex B – Table B.1, B.2, and B.3 load combinations as follows;
 For Ultimate Limit States $1.35 DL + 1.35 SIDL + 1.75 SUR + 1.5(LL+IM)$
 For Serviceability Limit States $1.00 (DL + SIDL) + 1.00 (LL+IM)$

1.2 AASHTO LOAD COMBINATION

AASHTO – Table 3.4.1-1 and 3.4.1.1-2 load combinations are summarized as follows;
 Strength I $1.25 DC + 1.50 DW + 1.75 (LL + IM)$
 Service II $1.00 (DC + DW) + 1.30 (LL + IM)$
 Extreme I $1.25 DC + 1.50 DW + 1.00 (LL + IM)$
 Fatigue I $1.50 (LL + IM)$

2. DESIGN DATA

- Overall Span of Bridge 16M, 20M, and 24M
- Effective Span of Bridge 15M, 19M, 23M
- Clear Carriage Way Width 7.500m
- Total Width 8.50 m
- Depth of Slab 250mm
- Depth of Girder 1.5 m
- Wearing coat 80mm
- Width of Girder 600mm
- Impact Factor
 - ✓ For IRC Class A and Class 70R Wheeled Loading
 - ✓ For AASHTO HI-93 Design Truck
- Load Combinations Considered
 - ✓ For IRC: $1.35 DL + 1.75 SIDL + 1.50 (LL + IM)$
 - ✓ For AASHTO: $1.25 DL + 1.50SIDL + 1.75 (LL + IM)$
- Centre to Centre Distance Between Longitudinal Girders 2.05 m
- Clear distance of cantilever span from face of Girder 0.875m
- Numbers of Longitudinal Girders 4 Nos.
- Numbers of Cross Girders 3 Nos.
- Grades of Concrete M 40
- Grade of Steel Fe 500
- Overall depth of super structure 1.75m
- Width * Depth of Kerb 500mm*320mm
- Live Load Considered
 - ✓ IRC Class A Wheeled Loading – For 2 Lanes IRC Class A
 - ✓ 70R Wheeled Loading – For 1 Lane
 - ✓ AASHTO HL-93 Design truck loading plus Lane Loading

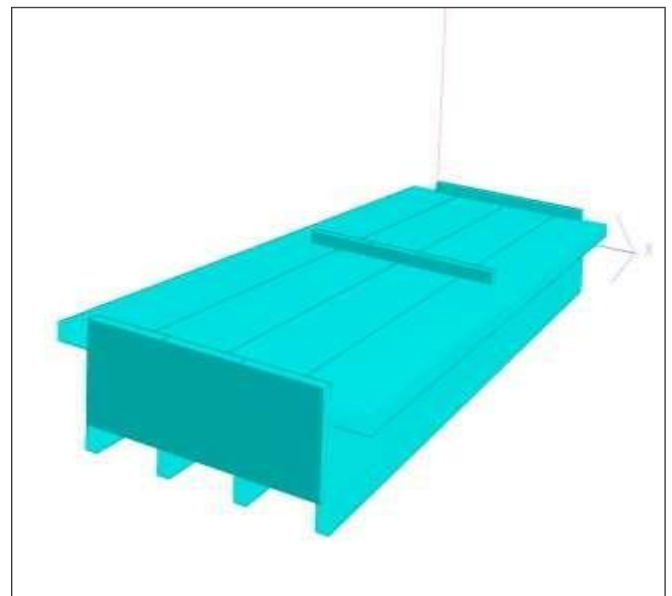
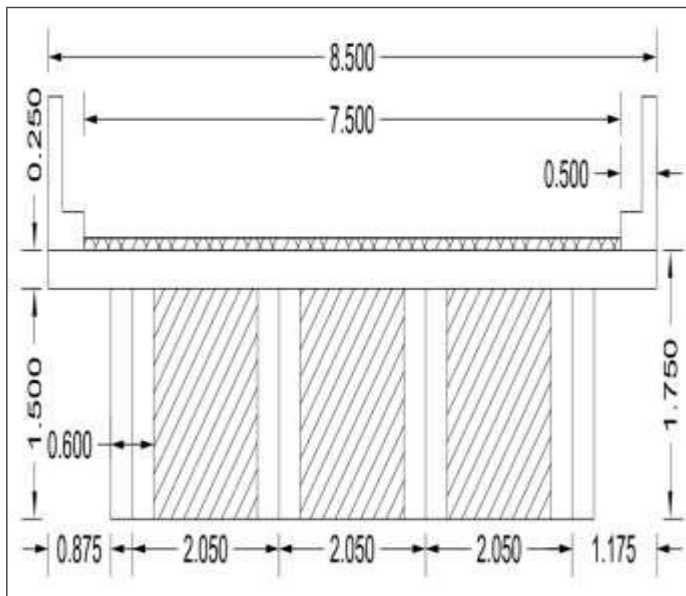

FIG. NO.8 C/S OF RCC T-BEAM BRIDGE AND STADD MODEL

3. STAAD ANALYSIS SUMMARY

3.1 SHEAR FORCE ON EXTERNAL AND INTERNAL GIRDER

Table 1

External Girder SF in MT						Internal Girder SF in MT					
LOADS	SPAN	Support	2L/8	3L/8	4L/8	LOADS	SPAN	Support	2L/8	3L/8	4L/8
	24M	25.88	13.50	6.75	1.13		24M	25.88	13.50	6.75	1.13
	20M	21.38	11.25	5.63	1.13		20M	21.38	11.25	5.63	1.13
	16M	16.88	9.00	4.50	1.13		16M	16.88	9.00	4.50	1.13
	24M	14.78	7.71	3.86	0.64		24M	14.78	7.71	3.86	0.64
	20M	12.21	6.43	3.21	0.64		20M	12.21	6.43	3.21	0.64
	16M	9.64	5.14	2.57	0.64		16M	9.64	5.14	2.57	0.64
	24M	3.97	2.08	1.00	0.09		24M	4.47	2.23	1.06	0.10
	20M	3.19	1.67	0.80	0.09		20M	3.75	1.89	0.89	0.10
	16M	2.45	1.28	0.60	0.09		16M	2.99	1.53	0.71	0.10
	24M	43.00	25.30	15.53	7.46		24M	42.59	22.95	14.33	7.02
	20M	37.63	21.93	13.42	6.65		20M	38.06	20.84	13.00	6.46
	16M	31.38	18.22	11.81	6.99		16M	33.18	18.48	11.98	6.92
	24M	26.30	17.52	11.95	8.21		24M	24.28	15.96	11.24	8.14
	20M	25.40	16.20	11.41	8.04		20M	23.87	15.00	10.72	8.03
	16M	22.44	14.59	10.63	7.66		16M	21.91	14.08	10.11	7.65
	24M	23.97	17.86	11.96	7.89		24M	38.06	22.58	18.01	16.66
	20M	20.71	14.85	9.41	5.65		20M	38.34	23.05	17.47	15.77
	16M	17.52	11.78	7.20	4.67		16M	37.28	22.07	14.76	14.12

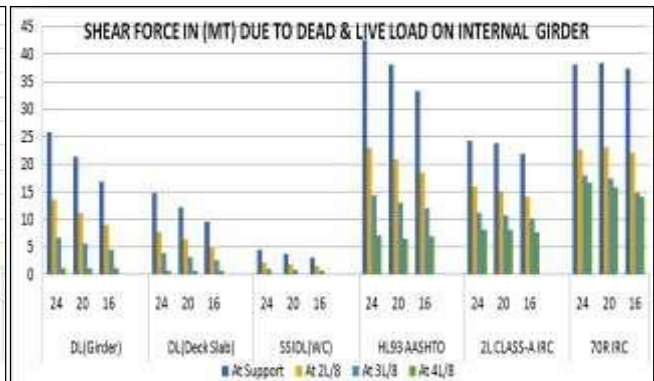
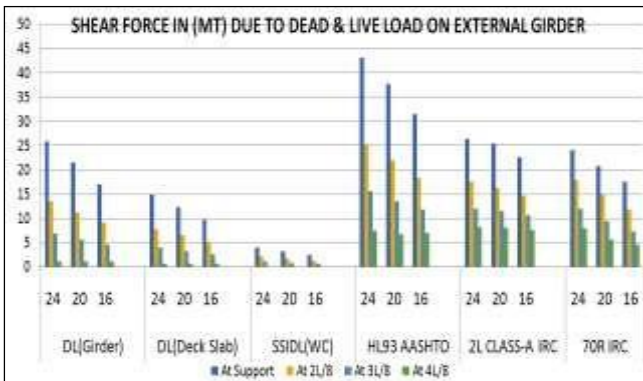

3.2 BENDING MOMENT ON EXTERNAL AND INTERNAL GIRDER

TABLE 2

External Girder BM in MT-m					Internal Girder BM in MT-m				
LOADS	SPAN	2L/8	3L/8	4L/8	LOADS	SPAN	2L/8	3L/8	4L/8
	24M	114.47	141.47	148.50		24M	114.47	141.47	148.50
	20M	78.47	96.75	101.25		20M	78.47	96.75	101.25
	16M	49.22	60.47	63.00		16M	49.22	60.47	63.00
	24M	65.37	80.79	84.81		24M	65.37	80.79	84.81
	20M	44.81	55.26	57.83		20M	44.81	55.26	57.83
	16M	28.11	34.53	35.98		16M	28.11	34.53	35.98
	24M	18.55	22.95	24.09		24M	19.70	24.31	25.51
	20M	12.47	15.36	16.08		20M	13.78	16.98	17.77
	16M	7.67	9.40	9.79		16M	8.83	10.85	11.30
	24M	180.12	215.55	227.53		24M	164.33	196.45	205.23
	20M	129.96	153.91	160.80		20M	122.28	145.15	150.07
	16M	86.38	104.33	108.19		16M	85.74	103.09	106.34
	24M	112.70	133.39	134.78		24M	101.46	120.18	120.72
	20M	85.46	103.02	105.20		20M	78.01	94.18	94.26
	16M	59.36	73.06	75.12		16M	55.69	68.03	69.42
	24M	120.43	153.76	164.73		24M	133.39	162.96	171.60
	20M	88.07	112.02	119.84		20M	112.82	137.54	145.08
	16M	59.40	75.06	79.10		16M	90.81	112.99	117.06

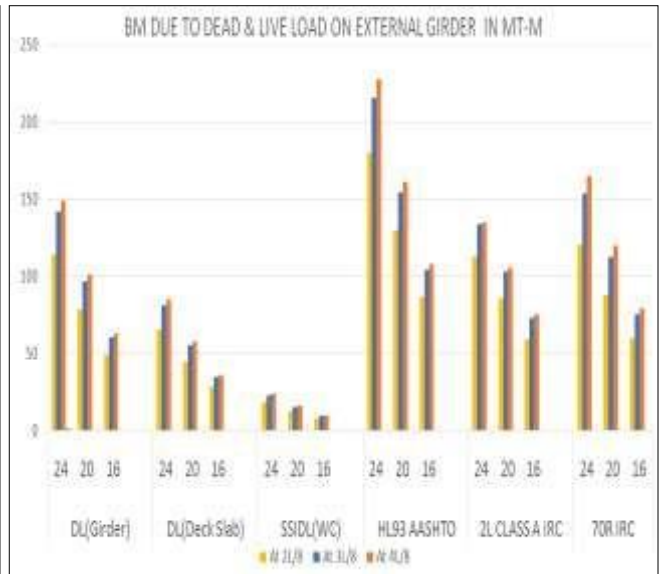
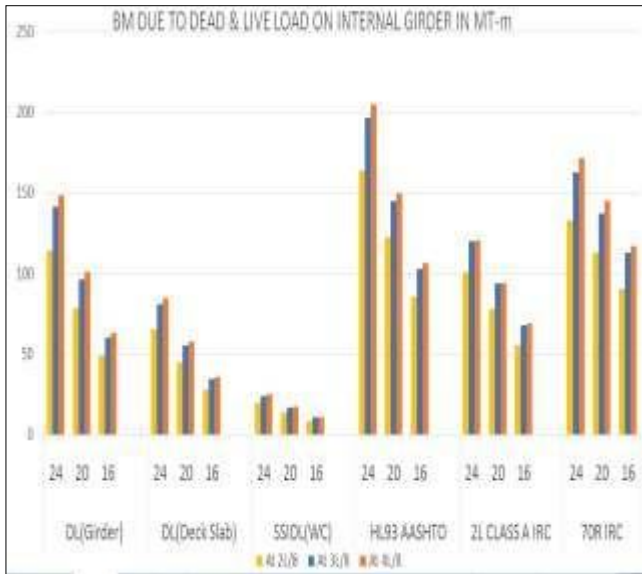

3.3 DEFLECTION AT MID SPAN OF EXTERNAL AND INTERNAL GIRDER

Table 3

DEFLECTION AT MID SPAN DUE TO Dead Load AND Live Load IN MM				
SPAN		HL93	2L CLASS A	70R
16 M		0.58	0.382	0.534
20 M		0.324	0.204	0.313
24 M		0.143	0.093	0.158
SPAN		HL93	2L CLASS A	70R
16 M		0.59	0.427	0.513
20 M		0.3	0.227	0.259
24 M		0.146	0.101	0.107



4. LOAD COMBINATION RESULTS

4.1 BENDING MOMENT ON EXTERNAL GIRDER DUE TO IRC AND AASHTO LOAD COMBINATION

TABLE 4

IRC COMBINATION B.M. (MT-M) 1.35 DL + 1.35 SIDL + 1.75 SUR + 1.5 LL						AASHTO COMBINATION B.M. (MT-M) 1.25 DL + 1.5 SIDL + 1.75 LL					
LOAD	SPAN	Support	2L/8	3L/8	4L/8	LOAD	SPAN	Support	2L/8	3L/8	4L/8
	24M	69.03	598.85	729.15	767.26		24M	72.58	627.19	762.37	802.43
	20M	52.85	395.36	478.08	499.95		20M	55.38	413.75	499.20	521.98
	16M	46.59	280.97	343.17	356.85		16M	49.29	296.65	362.07	376.42
	24M	54.93	497.73	605.90	628.13		24M	56.13	509.22	618.57	640.12
	20M	44.22	328.59	401.74	416.54		20M	45.32	335.86	410.13	424.68
	16M	40.64	240.43	296.27	307.25		16M	42.34	249.35	307.35	318.55
	24M	59.25	509.32	636.47	673.05		24M	61.17	522.75	654.23	692.52
	20M	47.22	332.51	415.24	438.50		20M	48.82	340.44	425.88	450.30
	16M	43.76	240.49	299.26	313.22		16M	45.99	249.42	310.84	325.52

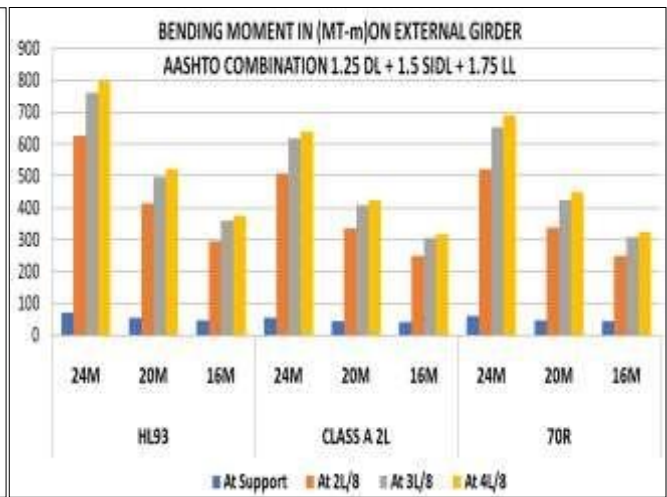
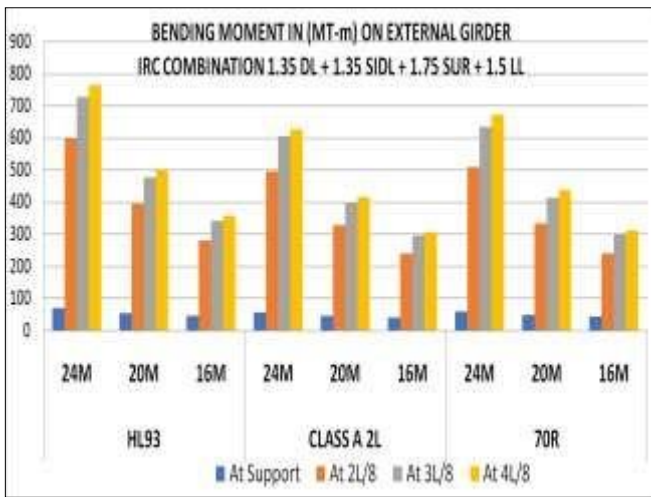

4.2 BENDING MOMENT ON INTERNAL GIRDER DUE TO IRC AND AASHTO LOAD COMBINATION

TABLE 5

IRC COMBINATION B.M. (MT-M) 1.35 DL + 1.35 SIDL + 1.75 SUR + 1.5 LL						AASHTO COMBINATION B.M. (MT-M) 1.25 DL + 1.5 SIDL + 1.75 LL					
LOAD	SPAN	Support	2L/8	3L/8	4L/8	LOAD	SPAN	Support	2L/8	3L/8	4L/8
	24M	63.68	542.62	660.95	692.35		24M	66.46	562.89	684.39	716.71
	20M	49.38	375.30	454.12	472.44		20M	51.44	390.25	471.13	489.78
	16M	44.64	250.86	305.60	316.86		16M	47.05	262.62	319.57	331.15
	24M	54.70	448.32	546.55	565.58		24M	55.98	452.88	550.92	568.82
	20M	42.43	308.91	377.67	388.74		20M	43.33	312.79	381.93	392.12
	16M	39.23	205.79	253.00	261.47		16M	40.73	210.03	258.20	266.54
	24M	56.54	496.21	610.72	641.90		24M	58.12	508.75	625.79	657.86
	20M	46.14	361.11	442.72	464.97		20M	47.67	373.69	457.82	481.06
	16M	42.56	258.45	320.43	332.95		16M	44.62	271.48	336.88	349.93

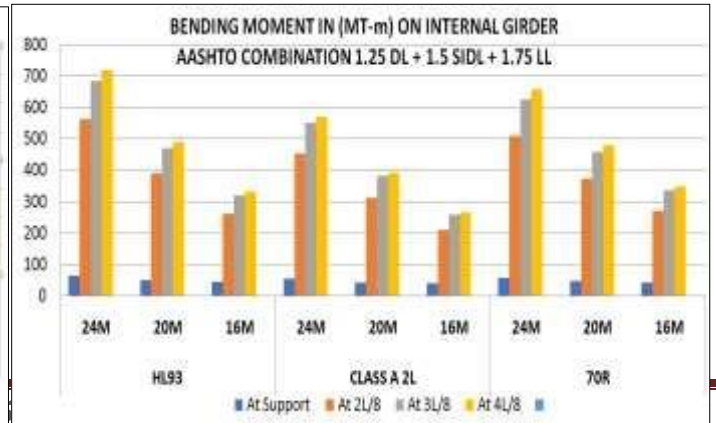
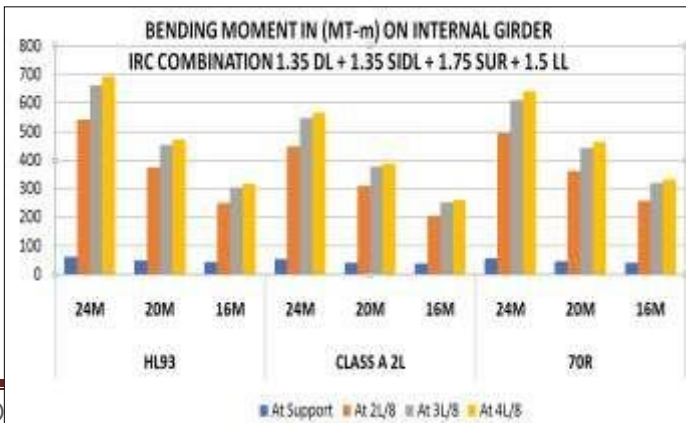

4.3 SHEAR FORCE ON EXTERNAL GIRDER DUE TO IRC AND AASHTO LOAD COMBINATION

TABLE 6

IRC COMBINATIN S.F. (MT) 1.35 DL + 1.35 SIDL + 1.75 SUR + 1.5 LL						AASHTO COMBINATION S.F. (MT) 1.25DL + 1.5SIDL + 1.75LL					
LOAD	SPAN	Support	2L/8	3L/8	4L/8	LOAD	SPAN	Support	2L/8	3L/8	4L/8
	24M	141.51	76.71	42.34	14.08		24M	148.88	81.11	45.24	15.78
	20M	111.46	61.56	34.33	12.61		20M	117.17	65.06	36.70	14.09
	16M	100.60	55.32	31.41	13.37		16M	106.68	58.88	33.84	14.96
	24M	116.45	65.04	36.96	15.21		24M	119.66	67.50	38.97	17.10
	20M	93.11	52.96	31.32	14.69		20M	95.76	55.03	33.19	16.51
	16M	87.19	49.88	29.64	14.37		16M	91.03	52.54	31.79	16.13
	24M	112.95	65.55	36.98	14.72		24M	115.57	68.10	38.99	16.53
	20M	86.08	50.94	28.32	11.11		20M	87.56	52.68	29.69	12.34
	16M	79.81	45.66	24.49	9.89		16M	82.42	47.61	25.78	10.90

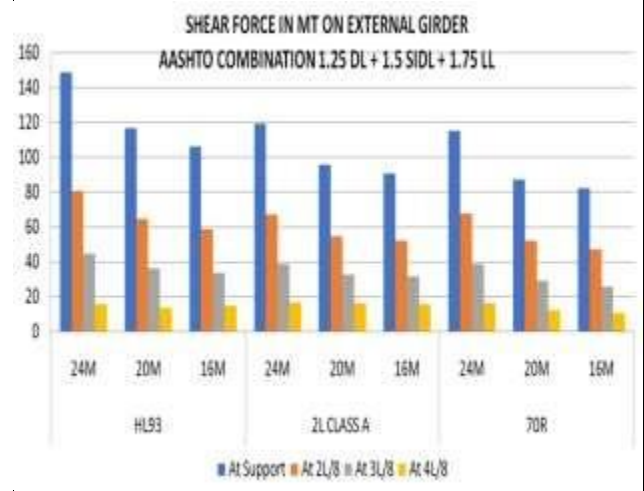
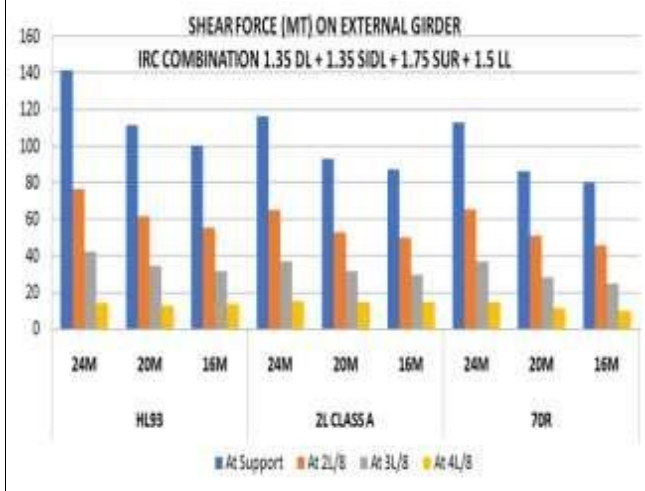

4.4 SHEAR FORCE ON INTERNAL GIRDER DUE TO IRC AND AASHTO LOAD COMBINATION

TABLE 7

IRC COMBINATION S.F. (MT) 1.35 DL + 1.35 SIDL + 1.75 SUR + 1.5 LL						AASHTO COMBINATION S.F. (MT) 1.25DL + 1.5SIDL + 1.75LL					
LOAD	SPAN	Support	2L/8	3L/8	4L/8	LOAD	SPAN	Support	2L/8	3L/8	4L/8
	24M	127.36	68.63	38.59	13.09		24M	132.92	71.88	40.95	14.64
	20M	109.53	58.50	33.00	12.25		20M	114.81	61.47	35.14	13.66
	16M	93.99	50.84	29.38	12.95		16M	99.24	53.81	31.56	14.48
	24M	99.90	58.15	33.96	14.78		24M	100.88	59.65	35.55	16.61
	20M	88.26	49.72	29.59	14.61		20M	89.99	51.24	31.17	16.41
	16M	77.07	44.23	26.57	14.04		16M	79.50	46.10	28.29	15.75
	24M	120.56	68.08	44.11	27.56		24M	124.98	71.24	47.39	31.52
	20M	109.96	61.80	39.70	26.23		20M	115.30	65.33	42.96	29.97
	16M	100.14	56.23	33.54	23.74		16M	106.42	60.10	36.42	27.07

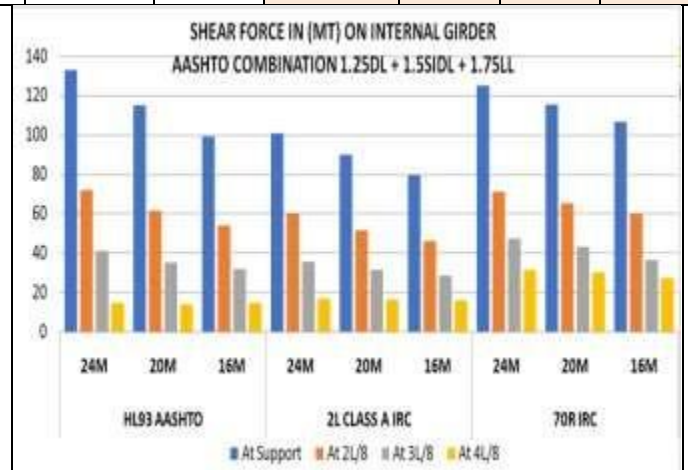
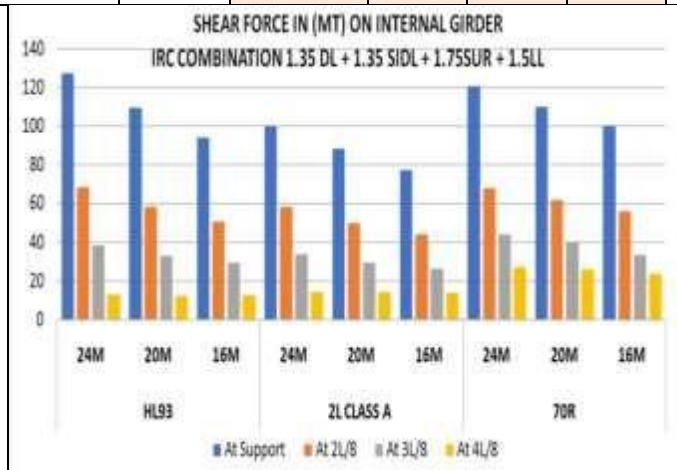

4.5 AREA OF MAIN STEEL REQUIRED AS PER AASHTO LOAD COMBINATION

TABLE 8

AST REQUIRED AASHTO COMBINATION					
LOAD	SPAN	AT L/4	AT 3L/8	AT L/2	
		24	8697.92	10866.48	11303.41
		20	5669.98	6930.70	7114.55
		16	4073.23	4970.75	5167.33
		24	6876.62	8430.31	8736.60
		20	4530.43	5529.46	5721.90
		16	3397.61	4189.15	4340.68
		24	7134.05	8935.89	9476.27
		20	4686.07	5771.13	6087.85
		16	3427.91	4238.95	4440.14
7761.08 9534.50 9900.80					
		24	7761.08	9534.50	9900.80
		20	5299.15	6463.31	6615.75
		16	3564.04	4332.40	4488.26
		24	6047.20	7365.51	7609.96
		20	4172.91	5092.00	5220.73
		16	2811.04	3455.85	3565.27
		24	6916.56	8478.23	8899.24
		20	5073.64	6231.15	6491.17
		16	3734.69	4579.70	4756.40

4.6 AREA OF MAIN STEEL REQUIRED AS PER IRC LOAD COMBINATION

TABLE 9

AST REQUIRED IRC COMBINATION					
LOAD	SPAN	AT L/4	AT 3L/8	AT L/2	
		24	8613.55	10768.16	11221.61
		20	5670.64	6939.84	7146.00
		16	4013.58	4902.16	5097.55
		24	7112.56	8766.27	9111.62
		20	4693.88	5738.77	5950.23
		16	3434.48	4232.21	4388.99
		24	7342.72	9201.75	9748.97
		20	4827.29	5945.92	6263.91
		16	3460.46	4274.90	4474.25
7920.93 9627.21 10019.51					
		24	7920.93	9627.21	10019.51
		20	5458.19	6563.12	6748.77
		16	3636.43	4365.37	4526.22
		24	6404.22	7853.46	8144.80
		20	4412.68	5394.93	5553.04
		16	2939.60	3614.04	3735.09
		24	7279.50	8813.52	9257.88
		20	5264.90	6364.13	6641.99
		16	3782.71	4577.33	4756.06

5. CONCLUSION

After analysis and design the 16m, 20m and 24m single span of RCC T- beam bridge using IRC 112- 2011 and AASHTO the results are compared. In other terms, limit state method of design is compared with AASHTO design technique. Therefore, conclusions which are made from the above comparisons are as follow

It is easier to find out behavior of bridge structure under different loading condition by using different codes and specification on Staad Pro. The software will be very helpful for analyzing the structure in short period of time and minimizing the hand calculation with accurate result for constructing the economical and safe structure.

From the STADD- Pro analysis result and the Table 1 & Table 2, without considering the load combination the value of shear force and bending moment are higher while AASHTO loading HL93 applied on external and internal girder compare to IRC Class A and 70R loading. Also, equal distribution of bending and shear force values in AASHTO.

The deflection as the AASHTO specification gives is slightly higher values than IRC code but the as the span is length of bridges increase there is reduction in deflection. So therefore, it can be concluded that AASHTO (LRFD) is much appropriate and optimal method for the design of RCC T-beam Bridge for all the spans.

In AASHTO, there is no such carriageway width and lane combinations of live load as specified in IRC code for different design vehicle, different lane, carriageway width because, In AASHTO, there is one design truck HL93, which has to run for all numbers of lanes for design purpose.

From the load combination both codes have its own circumscription which have different partial safety factor for loading. It is seen that AASHTO load combination has more safety factor for live load and lower to dead load compare to IRC load combination.

From Table no 4, 5, 6 and 7, the bending moment and shear force value are less for IRC compare to AASHTO, even higher safety factor in IRC load combination for dead load and super imposed load, this is due to higher factor and more safety norms for live load in AASHTO.

From the table 8 and table 9, the area of main steel required as the AASHTO and IRC are almost same. IRC code has the best load combination and design procedure compare to AASHTO specifications.

Both the code has own methodologies and design technique for various girder sections suitable for bridge superstructure to critically evaluate the structural performance with recent development and latest technologies.

6. ACKNOWLEDGEMENT

I would like to express my special thank of gratitude to my project guide Prof. Girish Sawai for their guidance and invaluable word of advice, support and help given to me to do this paper. Secondly, I would like to extend my gratitude to my parents and friends for their appreciation and belief in me.

7. REFERENCES

- [1] American association of state Highway and Transportation officials (AASHTO) Specifications. Load resistance and factor design bridge design specifications.
- [2] IRC: 21-2000 Standard Specification and Code of Practice for Concrete Road Bridges Section III Cement Concrete (Plain and Reinforced) Indian Road Congress, New Delhi.
- [3] IRC: 112-2011 Code of Practice for Concrete Road Bridges. Indian Road Congress, New Delhi.
- [4] IRC6:2017 Standard Specification and Code of Practice for Concrete Road Bridges Section II Loads and Load combinations. Indian Road Congress, New Delhi.
- [5] R.Shreedhar, SpurtiMamadapur, "Analysis of T-beam Bridge Using Finite Element Method," International Journal of Engineering and Innovative Technology Volume
- [6] Y. Yadu Priya, T. Sujatha, "Comparative Analysis of Post Tensioned T- Beam Bridge Deck by Rational Method and Finite Element Method," International Journal of Research in IT; management and Engineering, Volume 06 Issue 09, September 2016.
- [7] Patil M. B., Y. P. Pawar, S. S. Kadam, D. Mohite, S. V. Lale, C. M. Deshmukh & C. P. Pise, "Analysis and Comparative Study of Composite Bridge Girders" International Journal of Civil Engineering and Technology, Volume7 may-June 2016.
- [8] Abrar Ahmed, Prof. R.B. Lokhande, "comparative analysis and design of t-beam and box girders," International Research Journal of Engineering and Technology, Volume: 04, Issue: 07, July-2017.
- [9] Nivedhitha M, Gowtham Raja M and Sharu.E, "Design of RCC T-beam bridge considering overloading due to congestion," Indian J.Sci.Res. 17(2): 211 – 216; 2018.
- [10] Anisha Chauhan, Dimple Desai and BijalChaudhri, "A Review on Comparative Study of Bridge Super Structure with Reference to IRC And AASHTO Standards," International Journal of Technical Innovation in Modern Engineering & Science, Volume 4, Sept.2018.

- [11] Mayur Hingane, Payal Khobragade, Suvarna Raut, “Software Analysis of T-beam bridge on staad pro”. International Conference on Emanations in Mordern Engineering Science & Management, 2018.
- [12] S. Basilahamed and A. R. R. Kalaiyarrasi, “Comparative Analysis and Design OfTBeam Bridge Deck by Rational Method and Finite Element Method”. National Conference on Sustainable Construction Materials, March 2018.
- [13] Jagdish Chand, Ravikant, “Design and Analysis of Bridge Girders using Different Codes,” International Journal of Engineering and Innovative Technology, Volume 8 Issue 07, July-2019.
- [14] Bridge Design using the STAAD.Pro/ Beava”, IEG Group, Bentley Systems, Bentley Systems Inc.
- [15] “Design of Bridges”, Text book by N. Krishna Raju, 4th Edition Oxford & IBH Publishing Co. Pvt. Ltd. Engineering” second edition Text book by S. Ponnuswamy