

## **DESING AND ANALYSIS OF PELTON WHEEL**

G. Nagendra Kumar, M. Sai Krisnha, T.Sai Kiran Reddy

Guide: Mr. B. Phanindra Kumar

Department Of Mechanical Engineering

Bachelor Of Technology

Gurunanak Institute Of Technology  
Ibrahimpatnam, Ranga Reddy District-501506

### **ABSTRACT**

The Pelton wheel is a drive sort water turbine. It was imagined by Lester Allan Pelton in the 1870s. The Pelton wheel removes vitality from the motivation of moving water, rather than water's dead weight like the conventional overshot water wheel. Numerous varieties of motivation turbines existed preceding Pelton's outline, however they were less proficient than Pelton's plan. Water leaving those wheels normally still had rapid, diverting a great part of the dynamic vitality conveyed to the wheels. Pelton's oar geometry was composed so when the edge kept running at a large portion of the speed of the water stream, the water left the wheel with next to no speed; consequently, his outline separated the greater part of the water's motivation vitality—which considered an exceptionally proficient turbine.

In general all solid and non-solid model will deform when certain amount of thermal or structural loads applied within the environmental condition. In order to find the changes of the product or component, an analysis software is used. Ansys is an analytic software to find changes in deformation, Product life, Failures, heat flux(change of heat flow with respect to time and distance) and CFD (flow of air or water or any gas or liquid in the body).

In this project the model is Designed with respect to all the available constraints using an advanced cad softwares like Creo parametric, solid works, catia and solid edge. Later the product file is converted to ".STP" file format (standard exchange of product file) and imported to ansys workbench to find deformation and analytic valve with respect to the model or product definitions.

In this project the product was undergone various types of analysis to find frequencies with respect to gravity or mass by using Modal analysis and by Using static structural analysis total deformation, stress and strain valve, product life and failures etc., can be calculate by using Ansys workbench.

Ansys software helps to find the accurate or approximate solutions

## 1. INTRODUCTION TO PELTON WHEEL

The Pelton wheel is a drive sort water turbine. It was imagined by Lester Allan Pelton in the 1870s. The Pelton wheel removes vitality from the motivation of moving water, rather than water's dead weight like the conventional overshot water wheel. Numerous varieties of motivation turbines existed preceding Pelton's outline, however they were less proficient than Pelton's plan. Water leaving those wheels normally still had rapid, diverting a great part of the dynamic vitality conveyed to the wheels. Pelton's oar geometry was composed so when the edge kept running at a large portion of the speed of the water stream, the water left the wheel with next to no speed; consequently his outline separated the greater part of the water's motivation vitality—which considered an exceptionally proficient turbine.



Figure 1.1 Old Pelton Wheel



Figure1.2 Assembly of A Pelton Wheel

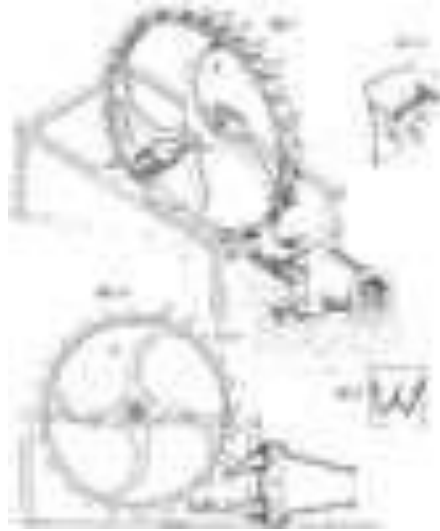

**Figure1.3Pelton's Original Patent (October 1880).**

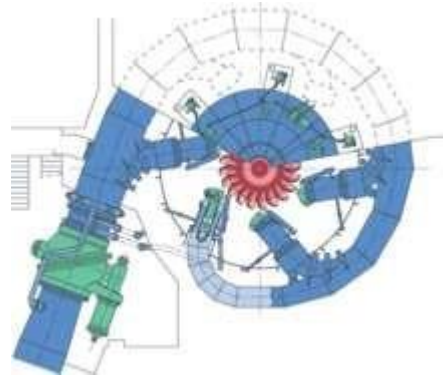

**Figure1.4 Sectional View Of A Pelton Turbine Installation**



**Figure1.5 Bucket Detail On A Small Turbine.**

### **1.1. Function**

Spouts coordinate commanding, rapid surges of water against a turning arrangement of spoon- molded containers, otherwise called motivation cutting edges, which are mounted around the circumferential edge of a drive wheel—additionally called a sprinter (see photograph, 'Old Pelton wheel.'). As the water stream encroaches upon the formed pail sharp edges, the heading of water speed is changed to take after the shapes of the container. Water motivation vitality applies torque on the basin and-wheel framework, turning the wheel; the water stream itself does a "u-turn" and exits at the external sides of the pail, decelerated to a low speed. Simultaneously, the water fly's force is exchanged to the hagggle to a turbine. Along these lines, "drive" vitality works on the turbine. For most extreme power and productivity, the hagggle framework is composed with the end goal that the water fly speed is double the speed of the turning pails. A little level of the water fly's unique dynamic vitality will stay in the water, which makes the basin be exhausted at a similar rate it is filled, (see preservation of mass) and along these lines permits the high-weight input stream to proceed continuous and without misuse of vitality. Commonly two pails are mounted one next to the other on the wheel, which licenses part the water fly into two equivalent streams (see photograph). This adjusts the side- stack powers on the hagggle to guarantee smooth, productive exchange of energy of the liquid fly of water to the turbine wheel.

Since water and most fluids are about incompressible, the majority of the accessible vitality is extricated in the primary phase of the pressure driven turbine. In this way, Pelton wheels have just a single turbine arrange, not at all like gas turbines that work with compressible liquid. It is utilized for creating power.

## 1.2. Applications

Pelton wheels mounted on vertical oil cushion heading in hydroelectric plants. The biggest units can be more than 400 megawatts. The littlest Pelton wheels are just a couple of crawls over, and can be utilized to tap control from mountain streams having streams of a couple of gallons for each moment. Some of these frameworks utilize family unit plumbing installations for water conveyance. These little units are suggested for use with 30 meters (100 ft) or a greater amount of head, so as to produce critical power levels. Contingent upon water stream and outline, Pelton wheels work best with heads from 15– 1,800 meters (50– 5,910 ft), in spite of the fact that there is no hypothetical farthest point.

## 1.3. Configuration Rules

The particular speed parameter is autonomous of a specific turbine's size. Contrasted with other turbine outlines, the moderately low particular speed of the Pelton wheel infers that the geometry is characteristically a "low rigging" plan. Therefore it is most reasonable to being sustained by a hydro source with a low proportion of stream to weight, (which means moderately low stream or potentially generally high weight).

The particular speed is the principle rule for coordinating a particular hydro-electric site with the ideal turbine sort. It additionally permits another turbine configuration to be scaled from a current outline of known execution.

$$\eta_s = n\sqrt{P} / \sqrt{\rho}(gH)^{5/4}$$

where:

- $n$  = Frequency of rotation (rpm)
- $P$  = Power (W)
- $H$  = Water head (m)
- $\rho$  = Density (kg/m<sup>3</sup>)

The formula implies that the Pelton turbine is *geared* most suitably for applications with relatively high hydraulic head  $H$ , due to the 5/4 exponent being greater than unity, and given the characteristically low specific speed of the Pelton.

## 2. LITERATURE REVIEW

The dynamic conduct of adaptable rotor frameworks subjected to base is researched hypothetically and tentatively by Aman Rajak et al. [1]. They have built up a scientific model for add up to vitality of the framework and the condition of movement has been inferred utilizing vitality technique. They expect the Pelton wheel turbine as a straightforward rotor plate framework. The gathering of a rotor plate framework as appeared in Figure 1. Dynamic conduct is then concentrated by building up a numerical model for rotor plate framework. They additionally have done the FEA examination utilizing ANSYS 14.5. Campbell graph is utilized to discover the characteristic recurrence of framework. The investigation concentrates on twisting marvel close to the basic rates of revolution. Lixiang Zhang et al. [2] have contemplated ANSYS limited Element programming to show the principal shaft framework in the hydro-turbine creating unit. On this premise, it takes the Modal investigation and utilizing Campbell outline computes the basic speed of revolution. The modular investigation is improved the situation discover the initial five mode shapes. As the working pace of revolution increments, because of the gyroscopic impact, the normal recurrence of the positive spin will increment while the negative spin diminishes. At the point when the speed of the pivot meets the rakish recurrence, it is the basic speed of turn. The outcomes can give a reference to dynamic investigation and an establishment for the plan or change.

Uzma Nawaz et al. [3] have examined the differential conditions for hydro framework and in light of the differential conditions, an exchange work is acquired. The investigative technique for figuring the stream of water through the penstock utilizes condition of movement and progression. These conditions utilized arithmetical and graphical techniques for taking care of transient strength issues. They have proposed a scientific model of the hydro sub- arrangement of a miniaturized scale hydroelectric plan for the transient and consistent state reactions working in recurrence control mode. It can be utilized amid configuration, testing and charging and also shaping the reason for authoritative concurrence on execution amid ordinary operation.

Chong-Won Lee [4] has considered Frequency-speed graph, regularly known as Campbell outline that has for some time been an essential device in the plan and operation of

turning apparatus. The development of the traditional recurrence speed outlines is talked about in connection to the coveted rotor dynamic properties of complex rotor frameworks.

The Campbell graph for straightforward general rotor framework appears in figure 2. This rotor display is extremely basic, yet it for the most part contains all the basic attributes of down to earth rotors. The Campbell chart for the general rotor as the rotational speed is differed. In the figure, the shaded regions demonstrate the unsteadiness speed locales. The Campbell graph is swarmed with an endless number (just twelve modes are appeared in the figure) of modes, which may all reason, from a certain point of view, resonances relying on the kind of outer powers. For instance, we can discover conceivable thunderous modes because of the unbalance excitation (set apart by broken line, notwithstanding for this straightforward general rotor display).

Jiaqi Liang, et al [5] has proposed the point-by-point dynamic displaying of pumped stockpiling hydro-plants for framework dynamic examinations. Both unbending and flexible dynamic models for various water burrow penstock arrangements are exhibited. The outcomes demonstrate that an unbending model is adequate for framework transient dynamic examinations, while a flexible model is more exact for long haul dynamic investigations. Specific consideration is paid to the elements of a flexible water demonstrate for the instance of a typical water burrow associated with different penstocks. Distinctive plant working conditions with various framework possibilities are considered.

Prakash K. Dhakan AND Abdul Basheer Pombra Chalil have exhibited the outline of packaging for four streams vertical Pelton wheel turbines is completed considering the size and state of the packaging. Packaging ought to have enough quality to meet the mechanical/basic necessities, for example, to withstand the dead weight of the generator, powers created in the complex/branch funnels, stack because of the four flies in various mixes and load because of different activation systems. In the wake of fulfilling above perspectives, the packaging ought to be checked for vibration conduct by modular examination. Through the auxiliary investigation utilizing ANSYS Mechanical programming, packaging configuration is advanced and a weight decrease of around 12% is accomplished. Vibration conduct of the packaging is dissected through the model examination and guaranteed the characteristic vibration of packaging is well over the working recurrence of turbine unit.

Ze li and lixiang Zhang has exhibited the numerical technique which could recreate the vibration of winding packaging structure that caused by the water stream in turbine stream section. The numerical reenactment of 3-D temperamental turbulent move through the stream section of turbine display is proficient by illuminating the N-S conditions, and the stream fields of stream entry and dynamic water weight on limit are acquired. In the meantime, the three measurement limited component dynamic model of solid structure is set up appeared in figure 4

J.C. Chavez et al. have dissected of a 16-basin Pelton impeller from a hydroelectric plant in Colombia, a plant with two turbo generators with an ostensible limit of 2.33MW each. Metallographic investigations were performed on the impeller zones close to the breaks; including an examination of the crack surface a computational reenactment of the liquid flow utilizing limited volume programming is finished. The computational liquid flow investigation allowed the recognizable proof of low-weight zones caused by a deficient geometry for the basin profile where cavitation is available. The limited component investigation allowed the ID of basic focuses on the container zone neck, harmonizing with the break found. This zone is under pliable worry because of the impacts of divergent power and pressure when the can interacts with the stream, causing weariness.

Amod Panthee et al. have presents Computational Fluid Dynamics (CFD) examination of Pelton turbine of Khimti Hydropower in Nepal. The motivation behind CFD investigation is to decide torque produced by the turbine and weight circulations in basin for additionally take a shot at weakness examination. The paper portrays the techniques utilized for CFD examination utilizing ANSYS CFX programming. 3 containers are utilized to anticipate the stream conduct of finish Pelton turbine. The weight conveyance is discovered most extreme at container tip and sprinter Pitch Circle Diameter (PCD). The torque produced by the center basin is recreated after some time to decide add up to torque created by Pelton turbine. The outcome demonstrated that SST display is powerful turbulence model to direct CFD examination of Pelton turbine.

Bilal Abdullah Nasir has clarified the Pelton water driven turbine with most extreme proficiency amid different working conditions the turbine parameters must be incorporated into the outline technique. In this paper all outline parameters were ascertained at most extreme productivity. These parameters included turbine control, turbine torque, sprinter breadth, sprinter length, sprinter speed, container measurements, number of cans, spout measurement



and turbine particular speed. A total outline of such turbines has been exhibited in this paper in view of hypothetical examination and some observational relations. The greatest turbine productivity was observed to be 97% steady for various estimations of head and water stream rate.

D Jost et al. have displayed a numerical examination of stream in a 2 fly Pelton turbine with Horizontal hub. The examination was improved the situation the model at a few working focuses in various Operating administrations. The outcomes were contrasted with the consequences of a trial of the model. Examination was performed utilizing ANSYS CFX-12.1 PC code. The numerical investigation of stream in the Pelton turbine was performed for a few working focuses. On the premise of the outcomes it can be closed: Accurate figuring of stream thickness and speed is critical for forecast of Pelton turbine proficiency. Numerical outcomes are adequately precise to be utilized for proficiency forecast in an outline procedure.

### **3. INTRODUCTION TO CATIA**

CATIA is a 3D solid modeling package which allows users to develop full solid models in a simulated environment for both design and analysis. In CATIA; you sketch ideas and experiment with different designs to create 3D models. CATIA is used by students, professionals to produce simple and complex parts, assemblies, and drawings. Design in a modeling package such as CATIA is beneficial because it saves time that would otherwise be spent prototyping the design.

Catia is the one of the computer aided three dimensional interface application with help of module and tools by parametric condition we can create any 3d dimensional components

#### **3.1 Catia Components - Parts**

Before we begin looking at the software, it is important to understand the different components that make up a CATIA model.

1. Part:
2. Assembly:
3. Drawing:

#### **3.2 Catia – Let's Begin**

- By default, no file is opened automatically when you start the program.
- To create a new file, click on File - New or click the New File icon in the main toolbar.
- This will open the New CATIA document wizard.
- Let's begin by creating a new part.
- To do this, click on Part, then OK. Once you do this, you will be brought into the modeling view

which should open several toolbars and panes.

### 3.3. Terminology

These terms appear throughout the CATIA software and documentation.

- Origin
- Axis
- Face
- Edge
- Vertex.

### 3.4 User Interface

The CATIA application includes user interface tools and capabilities to help you create and edit models efficiently, including:

➤ **Windows Functions:** The CATIA application includes familiar Windows functions, such as dragging and resizing windows. Many of the same icons, such as print, open, save, cut, and paste are also part of the CATIA application.

#### 3.4.1. Catia Document Windows:

CATIA document windows have two panels. The left panel, or Manager Pane, contains:

#### 3.4.2. Feature Manager /Design Tree

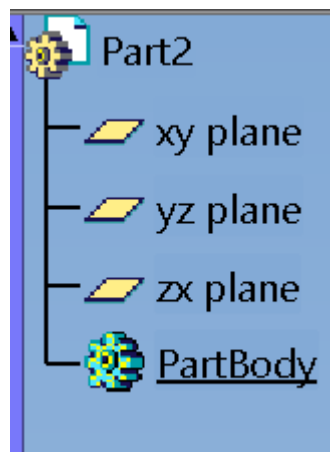

Figure 3. 1 Specification Tree

Displays the structure of the part, assembly, or drawing. Select an item from the Feature Manager Design tree to edit the underlying sketch, edit the feature, and suppress and un suppress the feature or component, for example.

- **Property Manager:** Provides settings for many functions such as sketches, fillet features, and assembly mates.
- **Configuration Manager:** Lets you create, select, and view multiple configurations of parts and

assemblies in a document. Configurations are variations of a part or assembly within a single document. For example, you can use configurations of a bolt to specify different lengths and diameters.

### 3.5. Modeling Of Pelton Turbine in Catia V5

#### Part 1 Wheel:

- To create propeller blade, go to Catia and open it. Now go to start and select mechanical design- part design then we will enter into part module. In part module- select sketcher in insert- and select xy plane.
- In sketcher module go to profile tool bar and select circle and specify radius. Then click on exist in workbench.
- in part module go to pad tool and specify as shown in figure.

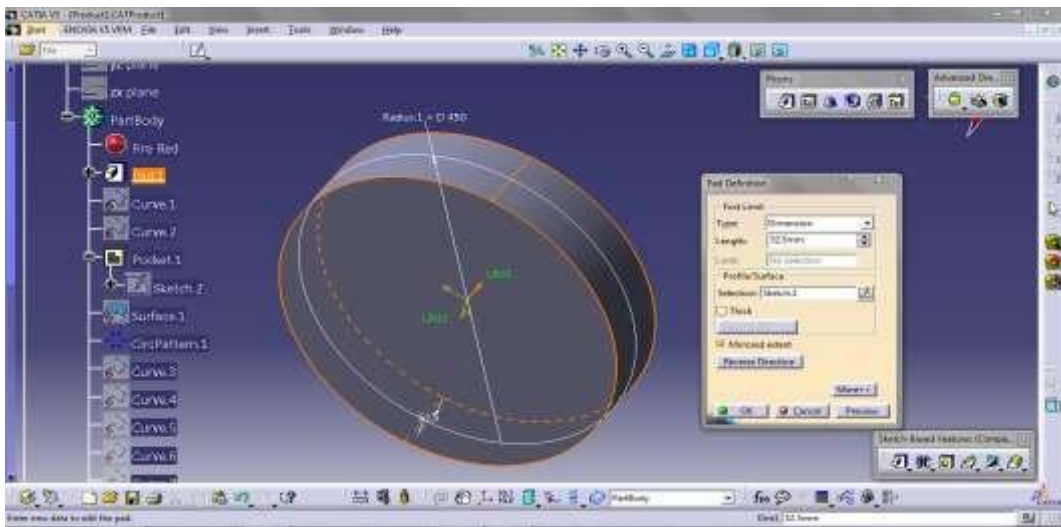

Figure 3. 2 Pad Definition

later create a hole and select circular pattern from transformation feature as shown in figure

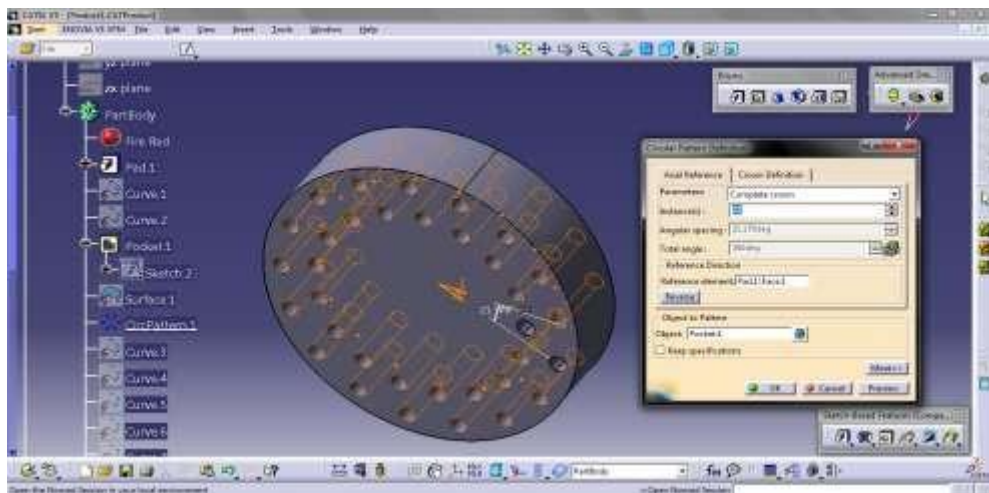

Figure 3. 3 Circular Pattern Definition

Part design then we will enter into part module. In part module- select sketcher in insert- and select xy plane.

- In sketcher module go to profile tool bar and select circle and specify radius. Then click on exist in workbench.

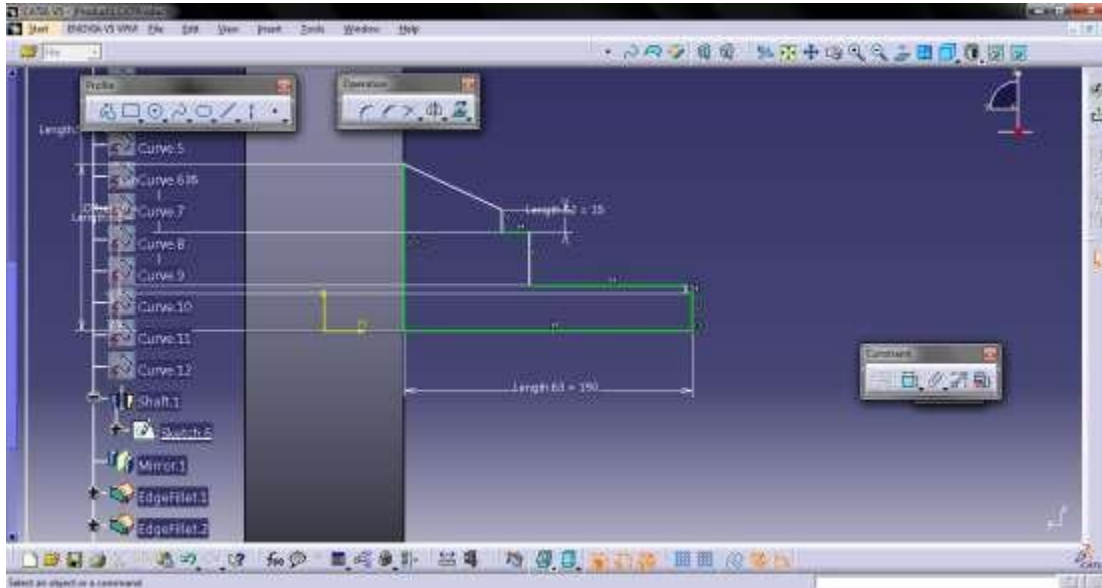

Figure 3. 4 Sketch Tools

- in part module go to shaft tool and specify as shown in figure.

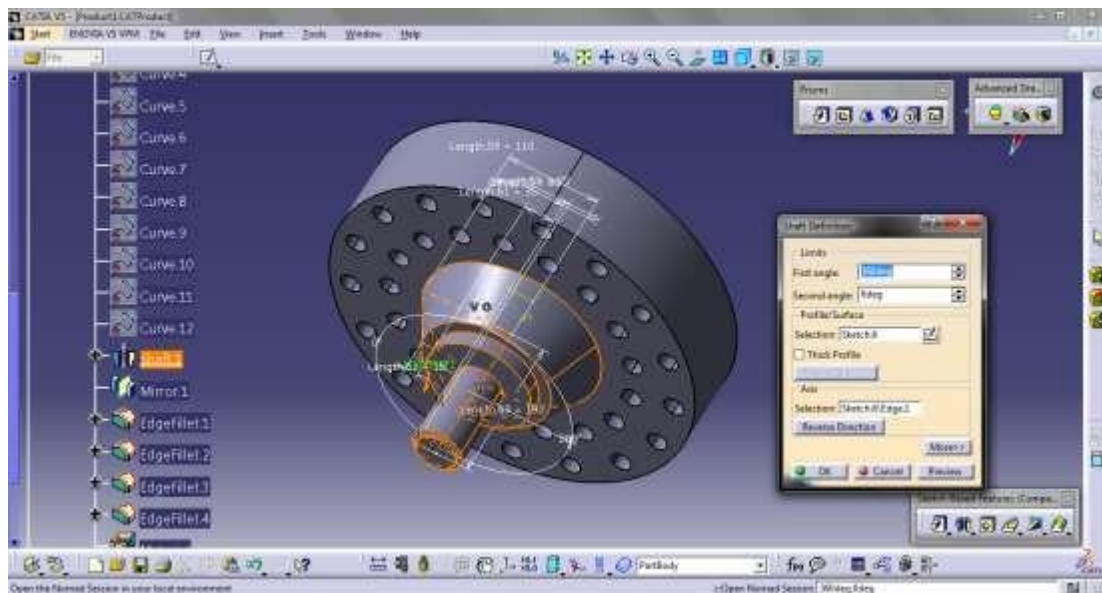
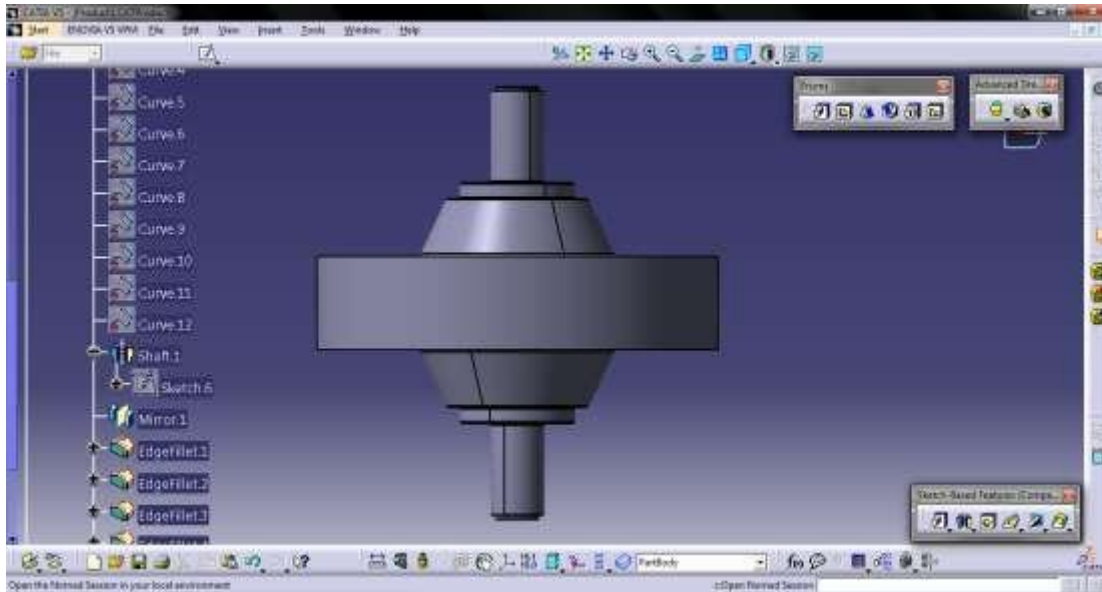
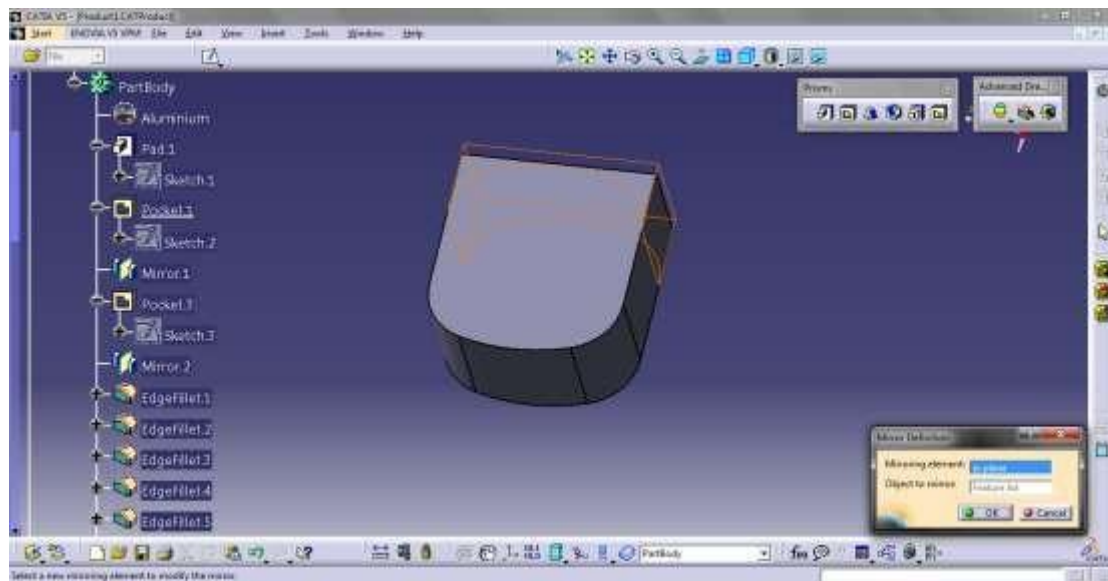

Figure 3. 5 Shaft Definition



**Figure 3. 6 Final Body of Pelton Wheel**

- To create propeller blade, go to Catia and open it. Now go to start and select mechanical design- part design then we will enter into part module. In part module- select sketcher in insert- and select xy plane.
- In sketcher module go to profile tool bar and select circle and specify radius on exist in workbench.
- in part module go to pad tool and specify as shown in figure.



**Figure 3. 7 Pad and Pocket Output**

- By using pocket tool and I here created the two-pocket hole on the surface of the body

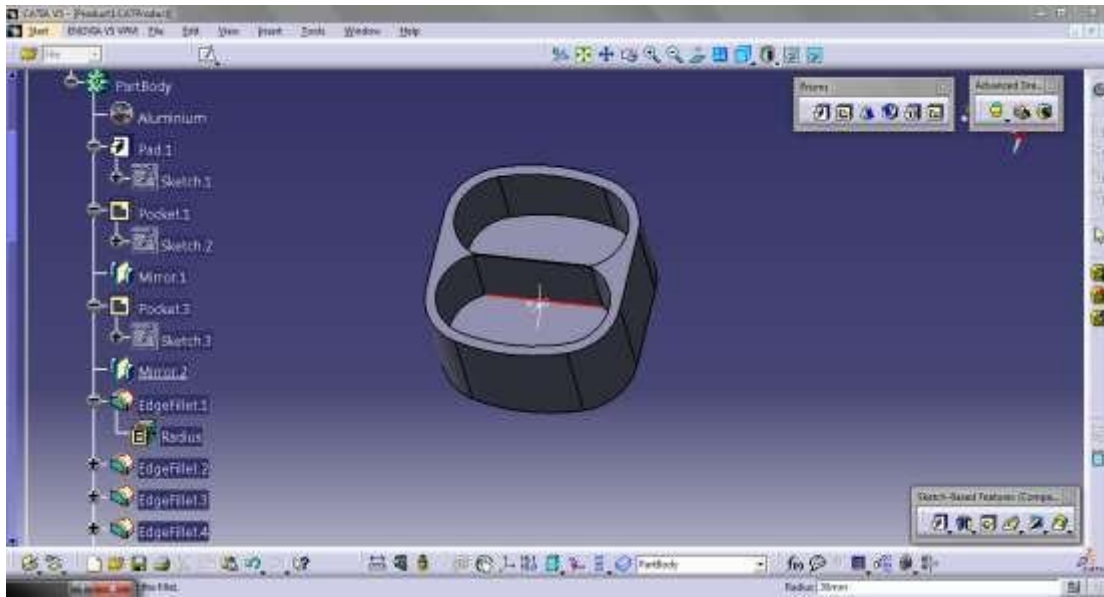

Figure 3. 8 pocket Definitions

- later select side surface as a plane and create a rectangle and by using pad tool select rectangle as reference profile specify as shown in figure

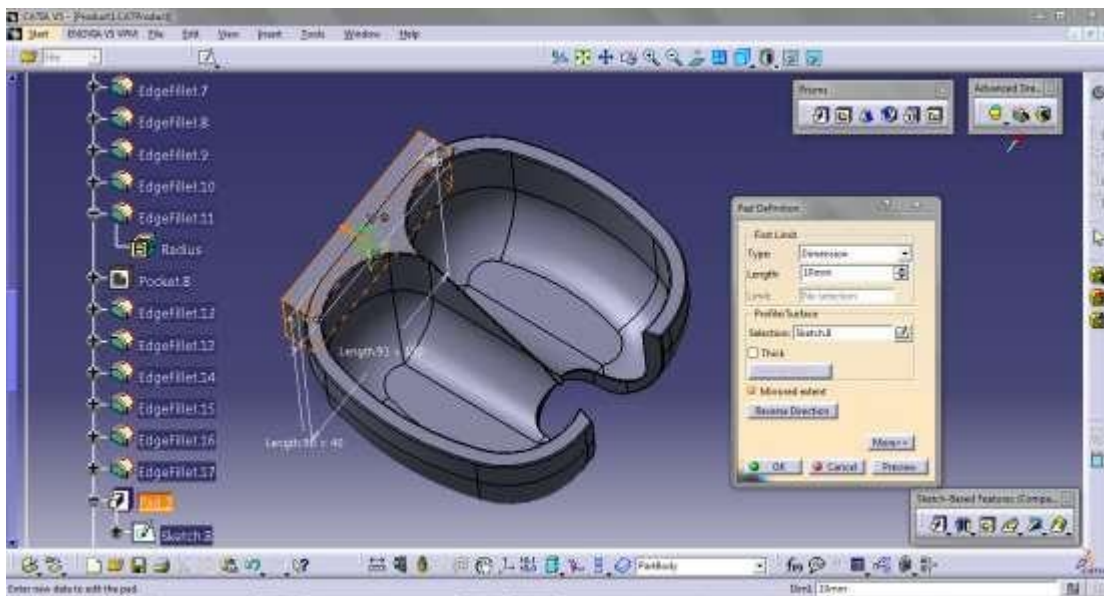

Figure 3. 9 Pad Definitions

- by using all tool as require here finally create the shape of the Pelton plate

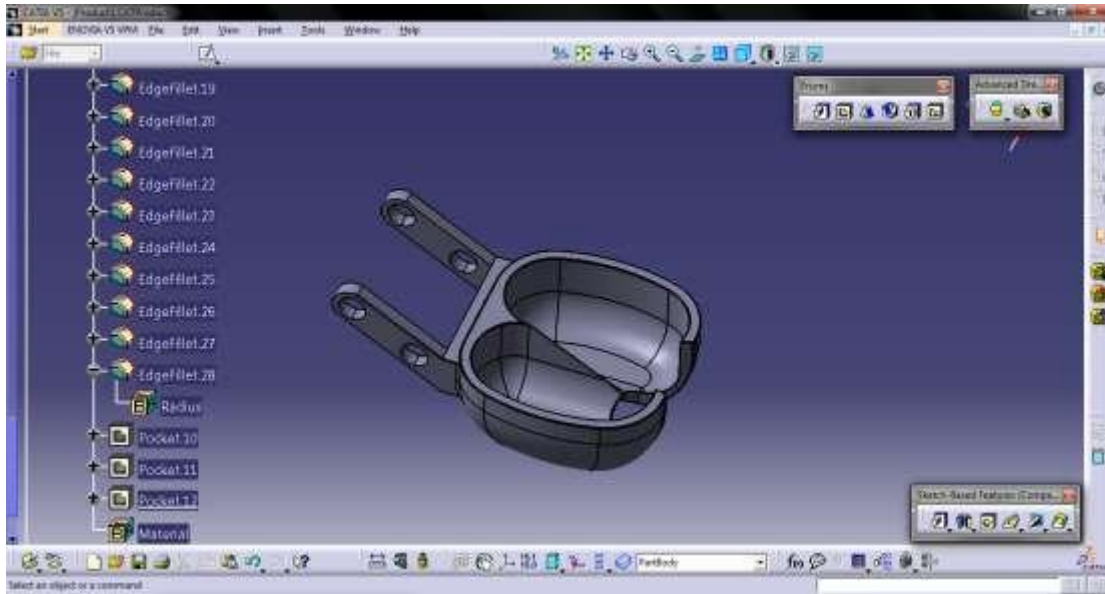

Figure 3. 10 Final

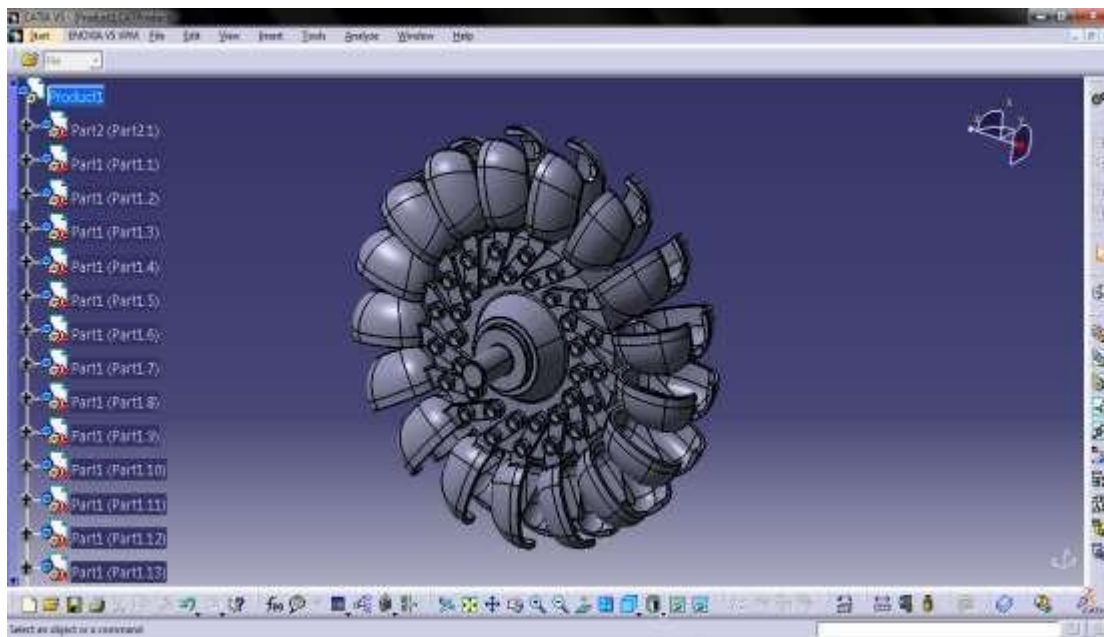

Figure 3. 11 Final design Of Pelton Turbine

## 4. INTRODUCTION TO ANSYS & MODAL ANALYSIS

### 4.1. Project Objective

In this chapter, we will be able to define:

- Understand the types of system
- Understand different types of cells
- Understand the graphic user interface of the workbench window
- Start a new project in Ansys workbench windows
- Add the first and subsequent analysis system to a project
- Set units for the project

Ansys workbench, developed by Ansys inc., usa, is a computer aided finite element modelling and finite element analysis tool (caem and caFea). In the graphical user interface gui of Ansys workbench the user can generate 3-dimensional and Fea models, perform analysis and generate results of analysis. We can perform a variety of tasks ranging from design assessment to finite element analysis to complete product optimisation analysis by using Ansys workbench. Ansys also enable the combination of standalone analysis system into a project and to manage the project workflow.

In Ansys workbench this are the list of analysis can be determined:

- Modal analysis
- Static structural analysis
- Transient structural analysis
- Steady state thermal analysis
- Transient thermal analysis
- Fluid flow (CFD)

### 4.2. Starting Ansys Workbench 16.0

To start Ansys workbench 16.0, choose start- programs/ all programs- Ansys 16.0 - workbench 16.0 from the taskbar. Alternatively, we can start Ansys workbench by double click on the workbench 16.0. The workbenches windows help streamline an entire project to be carried out in Ansys workbench 16.0. In this window, one can create, manage, and view the workflow of the entire project creates by using standard analysis system. The workbench windows mainly consist of



the menu bar, standard toolbar, the toolbar windows, project schematic windows, and the status bar.

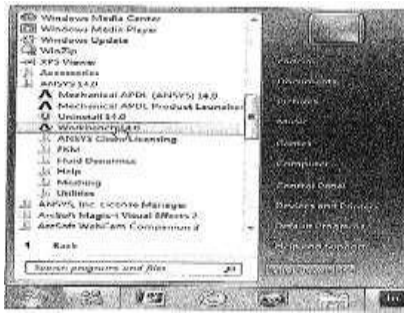

**Figure 4. 1 Starting Of Ansys Workbench Using Taskbar**

The workbenches windows help streamline an entire project to be carried out in Ansys workbench 16.0. In this window, one can create, manage, and view the workflow of the entire project creates by using standard analysis system. The workbench windows mainly consist of the menu bar, standard toolbar, the toolbar windows, project schematic windows, and the status bar.

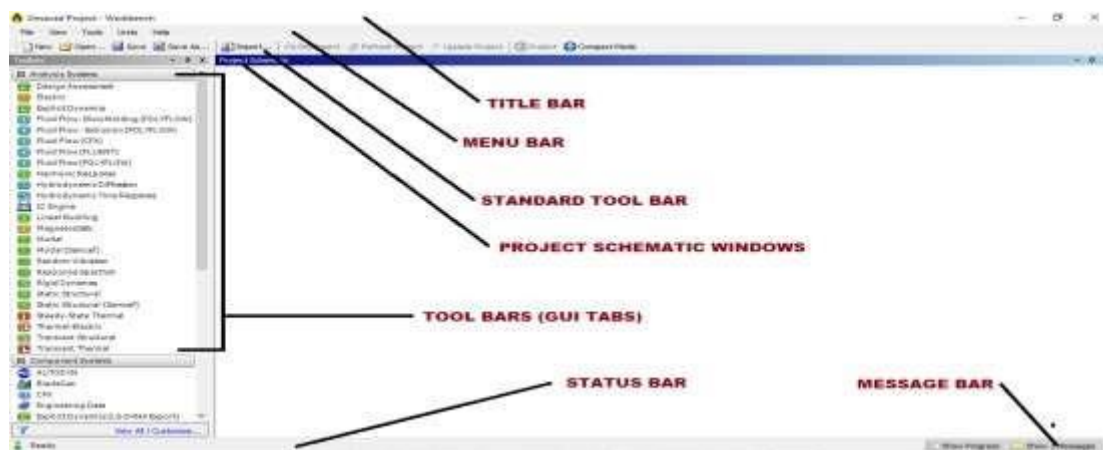

**Figure 4. 2 The Component Of The Workbench Windows**

### 4.3. Toolbox Windows

The toolbox windows are located on the left in the workbench windows. The toolbox windows list the standard and customised templates or the individual analysis components that are used to create a project. To create a project, drag a particular analysis or component system from the toolbox window and drop into the project schematic windows or double click on gui table it will add it into project schematic windows and to create the project



Figure 4. 3 The Analysis System Toolbox Displaying Various Analysis System In It.

#### 4.4. Table Of Analysis And Definitions

Table 1 Type Of Analysis And Results From Workbench

Name of analysis	Application of loads	Solution determines
Explicit dynamics	Loads with respect to time	Total deformation or impact deformation
Fluid flow (cfx)	Compressible or incompressible of air or gases	Heat transfer or flow of air
Fluid flow (cfd)	Compressible or incompressible of fluid	Heat transfer fluid
Harmonic response	Periodic or sinusoidal loads	Resonance, fatigue, and effect of forced vibration.
Rigid dynamics	Constraints and motion loads	Forces or direction analysis
Static structural	Static load conditions	Deformation, stresses and strains, fatigue tool, life, damages, safety factor
Steady state thermal	Temperature or thermal loads	Heat flux or temperatures
Transient structural	Varying of load conditions with changing of times	Deformation, stresses and strains, fatigue tool, life, damages, safety factor

Transient thermal	Varying of temperature or thermal loads with changing of times	Heat flux or temperatures
-------------------	--	---------------------------

### 4.5. Project Schematic Windows

The project schematics windows help manage an entire project. It displays the workflow of entire analysis project. To add an analysis system to the project schematic windows, drag the analysis system from toolbox windows and drop into the green coloured box displayed in the project schematic windows.

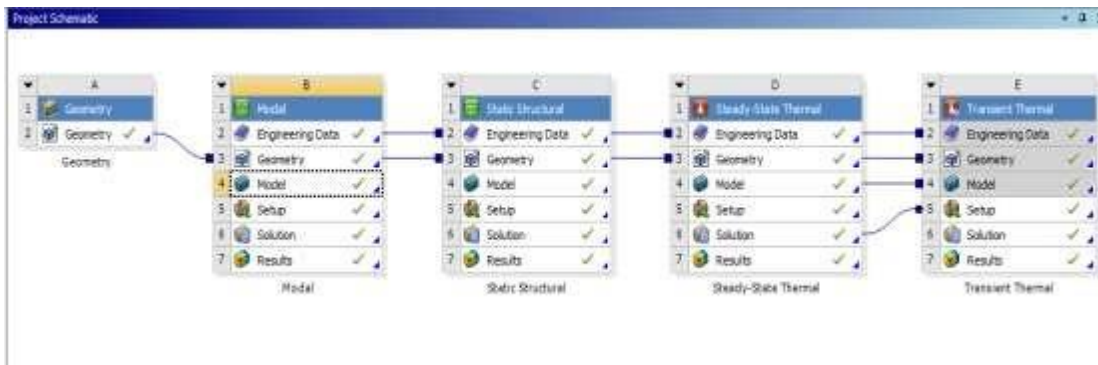

Figure 4. 4 Static And Thermal Analysis Imported Into Project Schematic

### 4.6. Custom System Analysis.

By default, the custom system toolbox is also displayed in collapsed state in the toolbox. To expand this node, click on + on a custom system. The system in the customs system toolbox is used to carry out the standard coupled analysis like static and thermal analysis(the combination of more than single or multiple of gui tab). In every gui tabs, we can drag more gui tabs makes the links analysis.

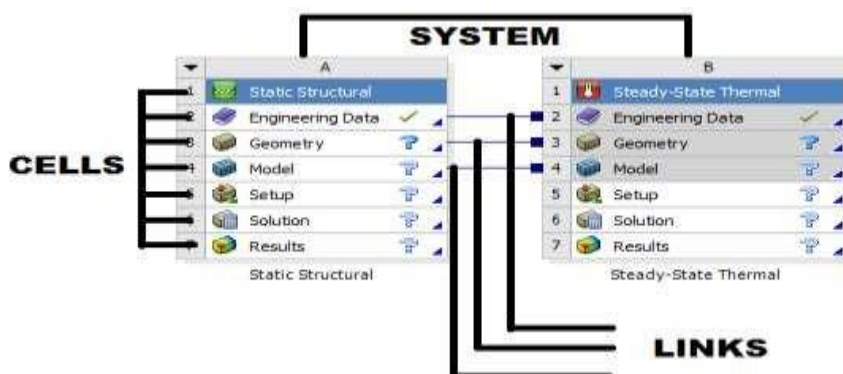

Figure 4. 5 Custom system analysis

#### 4.6.1. Units In Any Workbench:

In any workbench, you can use any of the following predefined unit systems.

Units	Mass	Length	Time	Voltage	Temperature	Current	Forces
Metric	Kg	M	S	V	°C	A	N
Metric	Tonne	Mm	S	Mv	°C	Ma	N
Us	Lb	In	S	V	°C	A	N
Si	Kg	M	S	V	K	A	N
Us engg.	Lb	In	S	V	(r)	A	Lbs

Table 2 Unit

#### 4.6.2. Component Of The System:

An item that is added from the toolbox window to the project schematic windows is known as a system and the constituent elements of the system are known as cells. Each cell of a system plays an important role in carrying out a project and are discussed next

- Engineering data cell** the engineering data cell is used to define the material to used in the analysis. To define the materials, double click on the engineering data cell, the workbench corresponding to this the engineering data cell will e displayed.

Engineering cell-double click-click on the shell system (engineering data book)-select general materials in the outline of the engineering data sources- select materials in the outline of general materials

- In this project the engine block is generally made up of cast iron or aluminum alloy

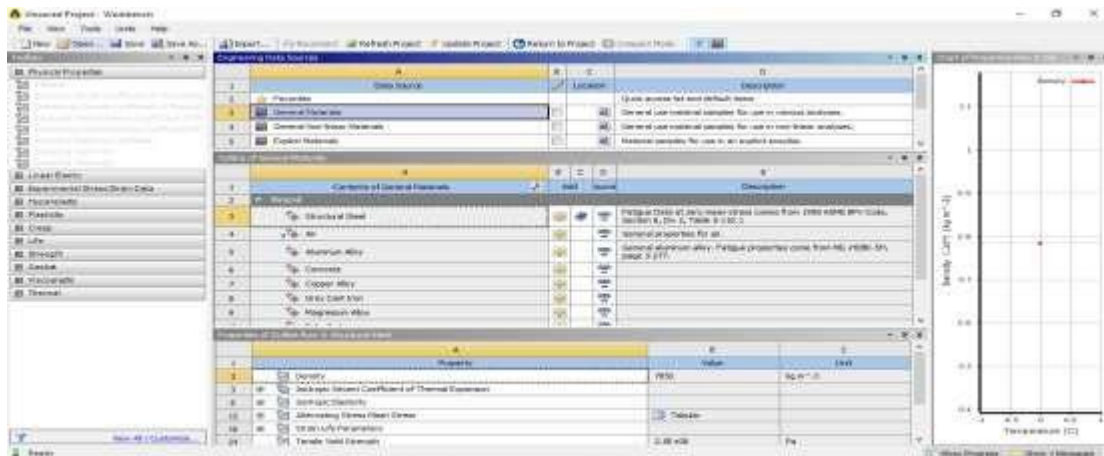
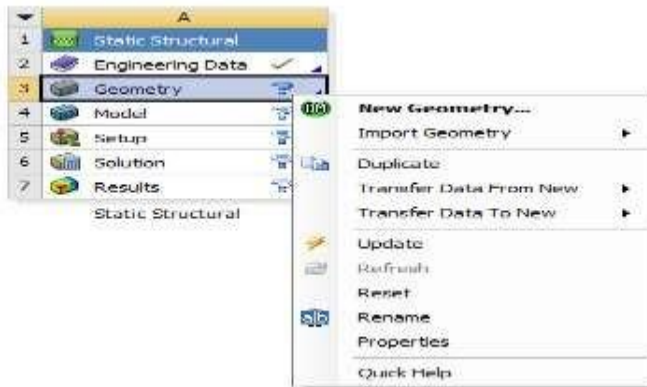

Figure 4. 6 The Engineering Data Workspace

- **Geometry cell** the geometry cell is used to create, edit or import the geometry that is used for analysis. To create a geometry for analysis, double click on geometry cell, the design modeller windows will be displayed.



**Figure 4. 7 The Shortcut Menu Displayed On Right Clicking On The Geometry Cell**

The new geometry option in the menu is used to get into design modeller windows, where you can create geometry or import the geometry from the existing geometry file create in another cad software packages.

- **Model cell** the model cell will be displayed for mechanical analysis system and is used to discredited geometry into small elements, apply boundary and load conditions, solve the analysis, and so on.
- **Mesh cell** the mesh cell will be displayed for fluid flow analysis and is used to mesh the geometry, on double clicking on this cell, the meshing windows will be displayed . In other words, this cell is associated with the meshing windows.
- **Setup cell** the setup cell is used to define the boundary conditions of an analysis system, such as loads and constraints. This cell is also associated with the mechanical workspace.
- **Solution cell** the solution cell is used to solve the analysis problem based on the conditions defined in the cells above the solution cell. The cell is also associated with the mechanical workspace.
- **Results cell** the results cell is used to display the results of the analysis in the user specified formats, this cell is also associated with the mechanical workspace.

## 4.7 Introduction To Model Analysis

The modal analysis is used to calculate the vibration characteristics such as natural frequency and mode shape (deformed shapes) of a structure or a machine component. The output of the modal analysis can be further used as input for the harmonic and transient analyses.

For example, a cantilever beam, attached to a system vibrating at a certain frequency. It is important for the designer to find out whether the beam will sustain the vibrations induced by the machine to which it is connected.

When the cantilever vibrates, various shapes are attained at certain frequencies. The shape of the component corresponding to a frequency is known as mode shape. The mode shape is a graphical representation of the deformation attained due to vibration. The main aim of the modal analysis is to find whether the natural frequency of the component is closer to the vibrations induced in the component. In this example, with this cantilever, the maximum number of modes found is six. Through display the various mode shapes of first, second, 3rd, and 4th modes, respectively.

If the natural frequency of a system is very close to the excitation frequency, the component can get into resonance and fail. Therefore, to avoid the resonance, you need to strengthen the component on the basis of the mode shape. However, sometimes strengthening the component may not be possible due to the design limitations. Also, in actual practice, the displacement produced at resonance may not be infinite due to the presence of damping. Therefore, you need to calculate the response of a system under the time/frequency based loads. If the stress/strain/displacement response is less than the permissible limit, the component will not be required to strengthen or redesign.

## 4.8 Performing The Modal Analysis

The modal analysis is performed to find out the natural frequencies of a model. You can find out more than one natural frequency of a model depending upon the degrees of freedom available.

The following steps are involved to perform a modal analysis:

1. Set the analysis preference.
2. Create or import the geometry into Ansys workbench.
3. Define element attributes (element types, real constants, and material properties).
4. Define meshing attributes.
5. Generate a mesh for the model.
6. Specify the analysis type, analysis options, and apply loads.

- 7. Obtain the solution.
- 8. Review the results.
- 9. Most of these steps have already been discussed in previous chapters.

### 4.9 Adding Modal Analysis System To Ansys Workbench

To perform a modal analysis in Ansys workbench, you need to add the modal analysis system from the analysis systems toolbox in the toolbox window to the project schematic window,

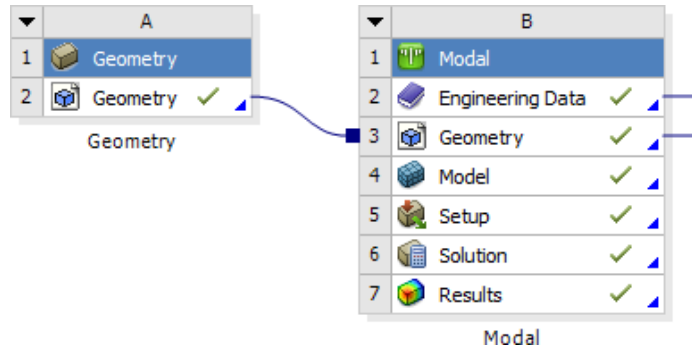

Figure 4.8 Project Schematic Window With The Modal Analysis System

### 4.10 Starting The Mechanical Window

To start the analysis, double-click on the model cell of the modal analysis system to display the mechanical window. The components of the mechanical window displayed by using the model cell of the modal analysis system are similar to the components of the mechanical window displayed by using the static structural analysis system.

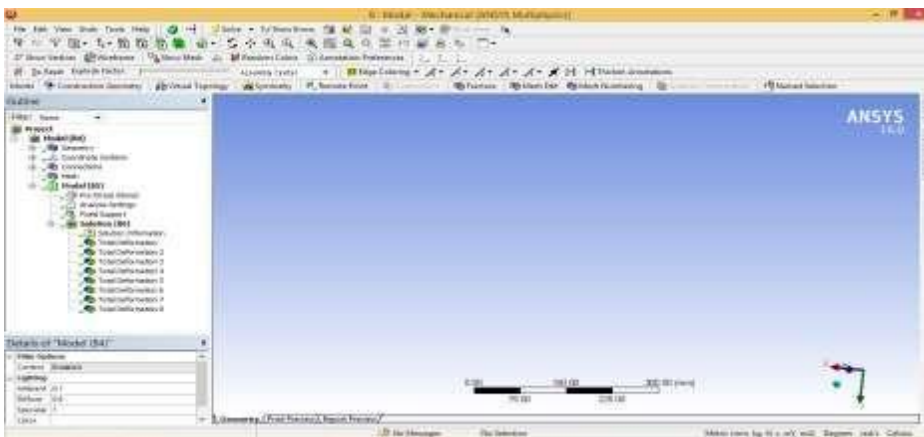

Figure 4.9 The Mechanical Window With The Modal In The Tree Outline

In the mechanical window, you can set the number of modes or natural frequencies you need To find shows the tree outline of the mechanical window.

### 4.11 Specifying Analysis Setting

After generating mesh for the model, it is required to specify the setting needed to run the modal analysis. To do so, select analysis settings displayed under the model node in the tree outline, the details of analysis settings windows will be displayed. In this windows, specify a value in the max modes to find edit box to displayed the various mode shapes. A limit can be assigned to the search of mode shape display by selecting yes from the limit search to range drop-down list. On doing so, the range minimum and range maximum edit boxes will be displayed. Specify the values for the minimum and maximum frequencies in these edit boxes to find mode shapes of the model within that specified range.

After the analysis setup is done, you need to solve the model. You can do so by choosing the solve tool from the standard toolbar in the mechanical window. After the model is solved, you need to plot the mode shapes. The procedure to plot the mode shapes is explained next.

### 4.12 Plotting The Deformed Shape (Mode Shape)

You can plot the mode shape (deformed shape) at each mode. However, before plotting the deformed shape, you need to specify the mode in the graph window. To create the mode shapes, select the solution node in the tree outline; the graph and tabular data windows will be displayed in the graphics screen,

Now right click in the graph window to display a shortcut menu and then choose select all from it. Right-click again in the graph window and then choose the create mode shape results option from the shortcut menu; the modes are added under the modal node. Based on the number specified in the max modes to find edit box, the number of modes are created with the names total deformation, total deformation 2, . . . Total deformation 6. Select the required mode from the solution node to visualize the corresponding mode shape in the graphics screen.

### 4.13 Project Objective

In this project, we imported a model which is created in one of the cad software's, as shown in figure. The dimensions of the model are given in figure. You will generate the mesh with default global mesh control settings and find six natural frequencies and their respective mode shapes. The material used is structural steel.

The following steps are required to complete this tutorial:

1. Opening above saved project..
2. Generate the mesh.
3. Specify the boundary conditions.



4. Solve the analysis.
5. Retrieve the analysis results.
6. Play the animation.
7. Save the model.

After creating the project, you now need to work in the design modeler to create the model.

1. Double click on the geometry cell; the design modeler window along with the Ansys workbench dialog box is displayed.
2. Select the millimeter radio button in the Ansys workbench dialog box and then choose the ok button to specify millimeter as the unit for creating the sketch.



**Figure 4. 10 Modal Geometry**

#### **4.13.1. Generating The Mesh For The Model**

Now, you need to generate the mesh of the model.;

1. Double click on model cell will enter into mechanical window. Also, you will notice that in the outline window, the mesh node is displayed in the tree outline with a yellow thunderbolt attached to it.
2. Click on mesh in the tree outline; the details of “mesh” window is displayed.
3. In the details of “mesh” window, expand the sizing node, if not already expanded
4. In the sizing node in the details of “mesh” window, (inter 2-5 in the element size edit box.
5. Right-click on mesh in the tree outline and then choose the preview > surface mesh from the shortcut menu displayed; the preview of the mesh for the model is displayed.

6. Choose the generate mesh tool from the mesh drop-down in the mesh contextual toolbar; the mesh is generated, as shown in figure.

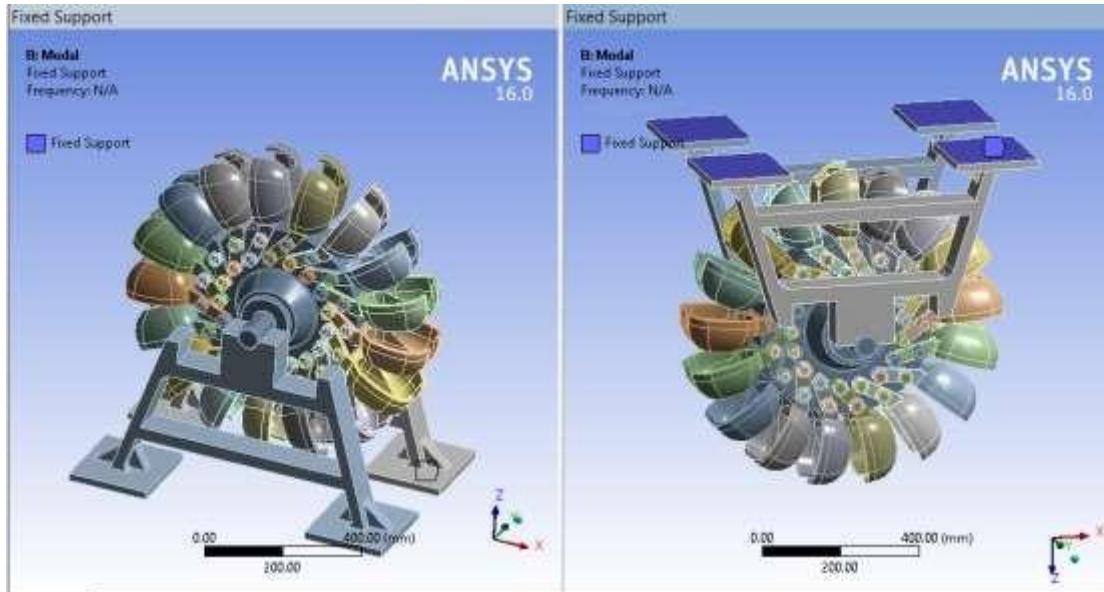

**Figure 4. 11 Mesh**

#### **4.13.2. Setting The Boundary Conditions**

After the mesh is generated, you need to set the boundary conditions under which the analysis is to be performed.

1. Right—click on modal node in the tree outline and then choose insert >fixed support from the shortcut menu displayed; fixed support with a question symbol is added under the modal node in the tree outline. Also, the details of “fixed support window is displayed.
2. In the details of “fixed support” window, click on the geometry cell to display the apply and cancel buttons, if not already displayed.
3. Select the side face of the model, as shown in figure.
4. Next, choose the apply button from the geometry selection box in the details of “fixed support’ window, fixed support is applied to the selected face.



**Figure 4.12 Fixed Supports**

#### 4.13.3. Solving The Modal Analysis

After specifying the boundary conditions in the mechanical window, you need to set the variables to define the results and solve the analysis.

1. Select analysis settings under the modal node in the tree outline; the details of “analysis settings” window is displayed.
2. In the details of “analysis settings” window, expand the options node, if it is not already expanded.
3. Enter 8 in the max modes to find edit box, if not already specified by default. Also make sure that no is selected in the limit search to range drop-down list, refer to figure.
4. Expand the solver controls node in the details of “analysis settings” window, if it is not already expanded.
5. In the damped drop-down list, select the no option, if not already selected.
6. Right-click on the solution node in the tree outline and then choose the solve option from the shortcut menu displayed; the analysis is solved.
7. Select the solution node in the tree outline; the graph and tabular data windows are displayed, refer to figure.

#### 4.13.4. Retrieving Analysis Results

After the analysis is solved, you need to find the mode shapes.

1. Right-click in the graph window, a shortcut menu is displayed

2. Choose select all from this shortcut menu to select all the data available in the graph window, as shown in figure,
3. After the columns-in the graph window are selected, right-click again to display a shortcut menu.
4. Choose the create mode shape results option from the shortcut menu displayed, refer to figure; total deformation results are added under the solution node in the tree outline with the names: total deformation, total deformation 2, - - - total deformation 8.

Also, you will notice that there are yellow thunderbolts attached to each one of them indicating that these results need to be evaluated. The number of modes under the solution node depend upon the value specified in the max modes to find edit box in the details of “analysis settings” window.

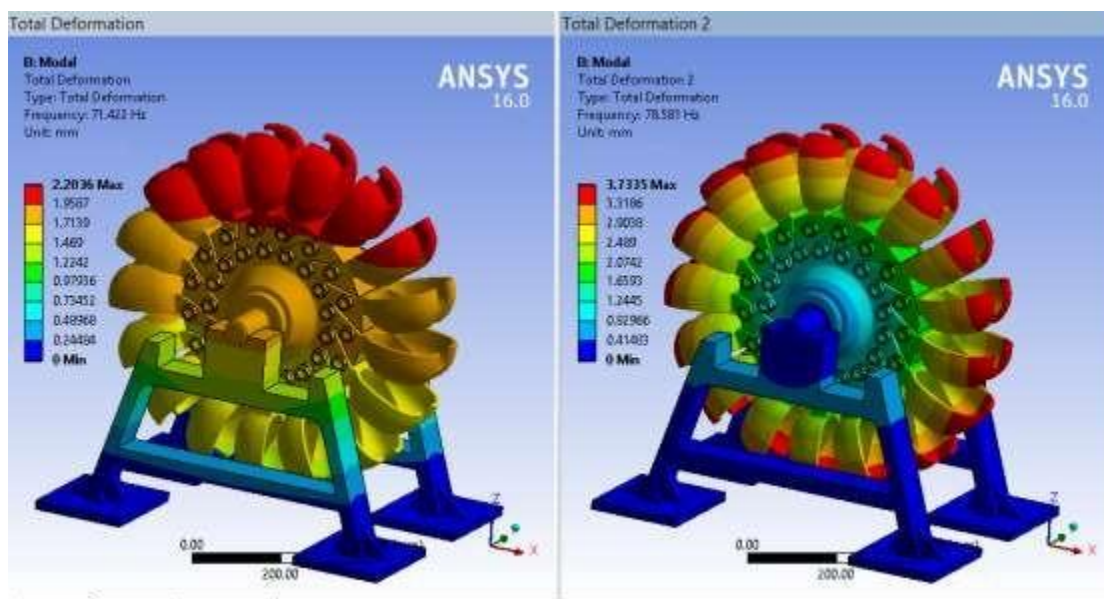

Figure 4.13 Total Deformation 1st, & 2nd

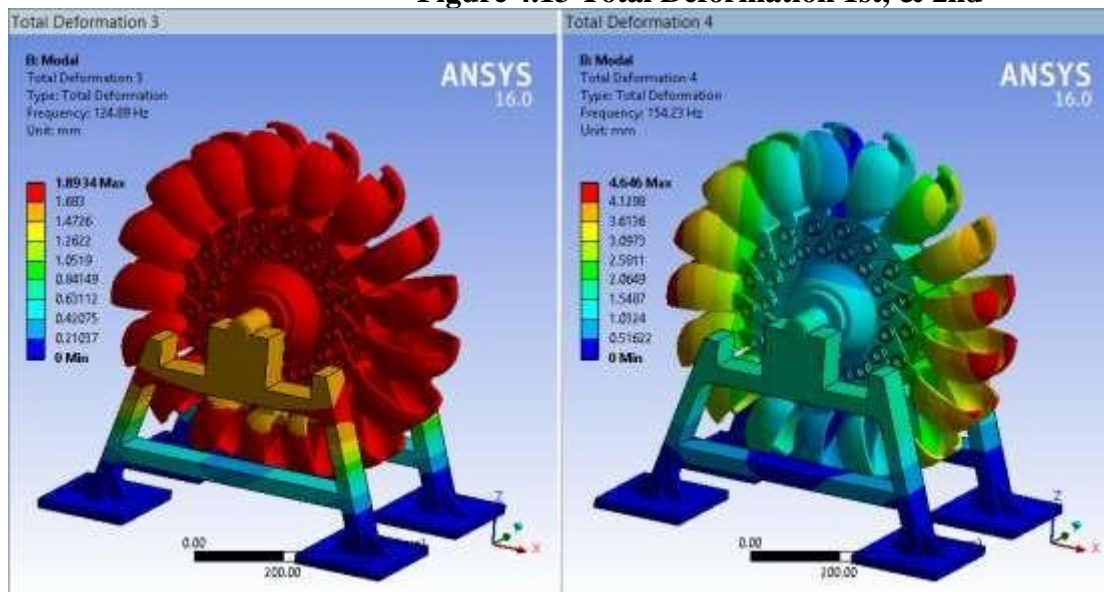

Figure 4.14 Total Deformation 3rd, & 4th

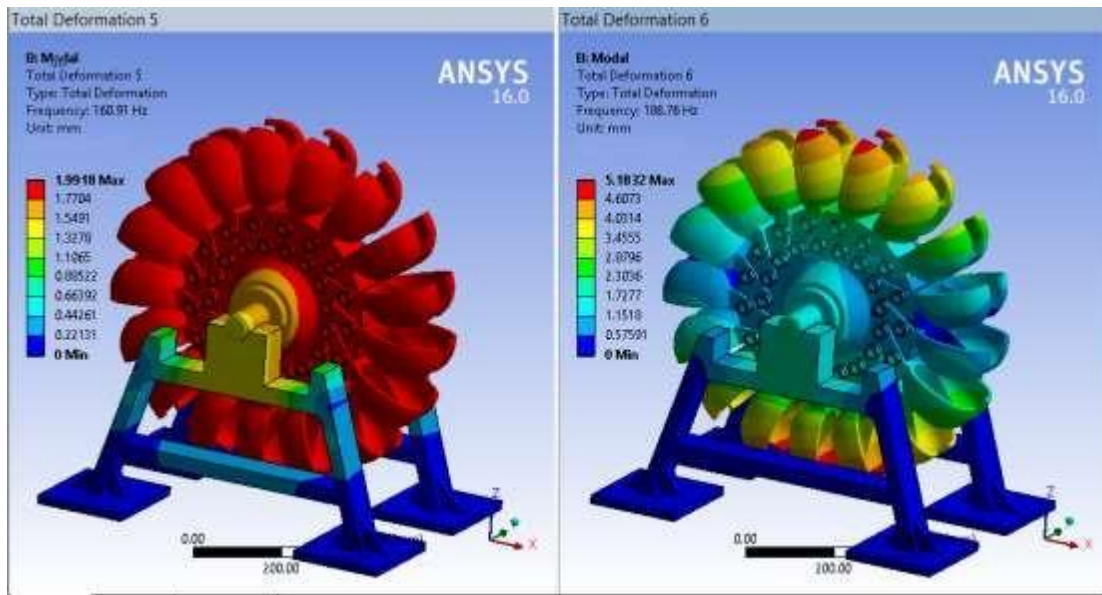

Figure 4.15 Total Deformation 5th & 6th

5. Right-click on the solution node - again and then choose the evaluate all results from the shortcut menu displayed; all the six results are ready to be viewed.
6. Select total deformation under the solution node in the tree outline; the first mode is displayed in the graphics screen, as shown in figure.
7. Select total deformation 2 under the solution node; the second mode shape is displayed in the graphics screen, as shown in figure
8. Similarly, select other results from the solution node to view the corresponding mode shape in the graphics screen.
9. Go to solution and right click on solution- summary of results from workbench

Results	Minim...	Maximum	Units	Reported Frequency (Hz)
Total Deformation	0.	2.2036	mm	71.422
Total Deformation 2	0.	3.7335	mm	78.581
Total Deformation 3	0.	1.8934	mm	124.89
Total Deformation 4	0.	4.646	mm	154.23
Total Deformation 5	0.	1.9918	mm	160.91
Total Deformation 6	0.	5.1832	mm	186.76

Figure 4.16 Results Summary

## 5. STATIC STRUCTURAL ANALYSIS

### 5.1 Project Objective

In this project, we will be able to define total deformation and stress, etc

- Create the static structural analysis system
- Apply different types of materials
- Applying of boundary conditions
- Apply a different type of constraints
- Apply different loads
- Generate the results as per required
- Generate project reports

In this project, we imported the geometry of the component show the dimensions for the component with respect to the load applications. The material to be applied on the model is stainless steel. Next, you will run the analysis under two conditions and evaluate the total deformation, directional deformation, equivalent stress, maximum principal stress, and minimum principal stress.

The static structural analysis is one of the important analyses in Ansys workbench. It is available as static structural analysis system under the analysis system toolbox in the toolbox window, this system analyses the structural components for displacements (deformation), stresses, strains, and forces under different loading conditions. The loads in this analysis system are assumed not to have damping characteristics (time dependent). Steady loading and damping conditions are assumed in this type of analysis system.

To start a new static structural analysis system, double-click on static structural in the analysis systems toolbox in the toolbox window; the static structural analysis system will be added to the project schematic window. To start an analysis, first you need to specify the geometry on which the analysis is to be done. To do so, you can import the geometry from an external cad package, or you can create the geometry in the Ansys's design modeler software. After the model is specified for an analysis, you need to double-click on the model cell of the static structural analysis system to open the mechanical window. In this window, you can specify the parameters and run the analysis.

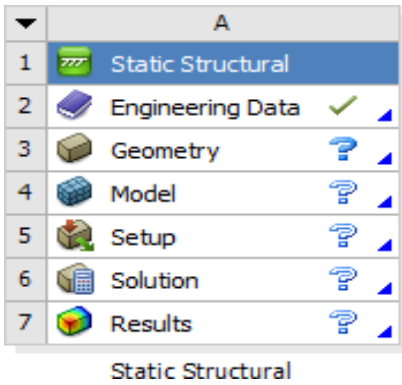

**Figure 5. 1 The Static Structural Analysis System Added To The Project Schematic Window**

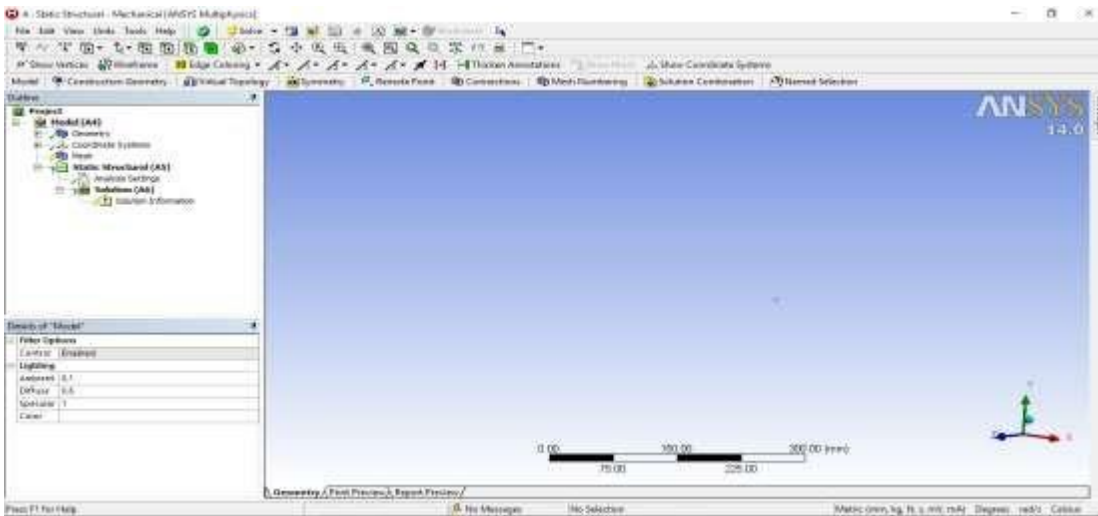

**Figure 5. 2 The Mechanical Window**

As discussed in previous chapters, analysis can be carried out in three major steps: pre- processing, solution, and post-processing. The tools required to carry out these steps are discussed next.

## 5.2 Pre-Processing

The pre-processing of an analysis system involves specifying the material, generating a mesh, and defining boundary conditions.

In Ansys workbench, the various tools related to boundary conditions are available in the environment contextual toolbar, which is displayed when you select the static structural node in the tree outline

In order to provide a support to the model, you need to choose the required tool from the supports drop-down. Similarly, to add a load, choose the desired tool from the loads drop-down

in the environment contextual toolbar. Also, when you choose any tool from the environment contextual toolbar; the corresponding entity is placed under the static structural node in the tree outline.

The main purpose of an analysis is to evaluate the results. After the boundary condition is set and loads are applied, you need to specify the desired outcomes of the analysis. In Ansys workbench, you can analyze various parameters such as deformation, stresses, strains, and so on. To do so, you need to specify the results required and then evaluate them. You can use the tools available in the solution contextual toolbar to specify results, refer to figure 9-4. Alternatively, right-click on the solution node in the tree outline and then use the desired option from the shortcut menu displayed.

In order to evaluate deformations, stresses, strains, and so on, choose the desired options from the drop-downs available in the solution contextual toolbar.

### **5.3 Solution**

In an analysis, after pre-processing (meshing, specifying material, and specifying boundary condition) is done, the next step is to solve the analysis. In Ansys workbench, you will use the solve tool from the standard toolbar to run the solver. The solver runs in the background of a software and acquires results of an analysis, based on the specified boundary conditions.

### **5.4 Post-Processing**

After the analysis is complete, you need to generate the report in the mechanical window. To do so, choose the report preview tab from the bottom of the graphics screen; the Ansys report generation in progress message is displayed on the screen. After sometime, this message vanishes and the report is generated.

### **5.5 Project Overview**

In this project, you will create the model. The dimensions to create the model and its boundary and loading conditions are also given in the same figure. Run a static structural analysis on the model and evaluate the total deformation and the directional deformation. Determine directional deformation along the x, y, and z axes. After evaluating the results, interpret them

- A. Start a new project and create the model.
- B. Generate the mesh.
- C. Set the boundary and loading \_conditions.
- D. Solve the model.
- E. Duplicate the existing analysis system.



- F. Interpret results.
- G. Save the project.

### 5.5.1. Starting A New Project And Creating The Model

The first step is to start a new project in the workbench window.

1. Start Ansys workbench.
2. Choose the save button from the standard toolbar; the save as dialog box is displayed.
3. Double-click on static structural in the toolbox window; the static structural analysis system is added in the project schematic window.
4. Rename the static structural analysis system (if).
5. Double-click on the geometry cell; the design modeler window along with the Ansys workbench dialog box is displayed.
6. In the Ansys workbench dialog box, set the unit to millimeter. Now, create the model on the xy plane
7. Exit the design modeler window to display the workbench window.

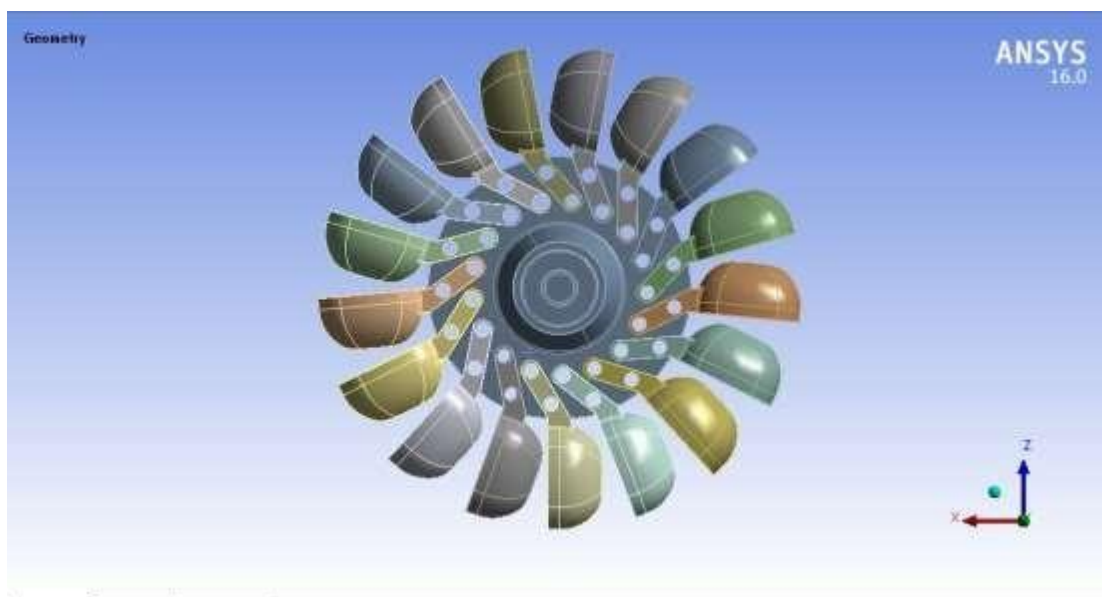

Figure 5. 3 Modal In Static Structural Analysis

### 5.5.2. Adding The Material To The Engineering Data Figure Workspace

After creating the holes in the model, you now need to apply the material to it. The material to be applied is stainless steel.

1. Double-click on the engineering data cell of the spring plate analysis system; the engineering data workspace is displayed in the workbench window.

2. Choose the engineering data sources toggle button from the standard toolbar; the engineering data sources window is added to the engineering data workspace.
  3. In the engineering data sources window, select the general materials library to display the outline of general materials window.
  4. In the outline of general materials window, choose the plus symbol corresponding to aluminum alloy; the material is added to the engineering data in the outline window of the engineering data workspace.
  5. Again, choose the engineering data sources toggle button from the standard toolbar to switch to the default view of engineering data workspace.
- Choose the return to project button from the standard toolbar to display the

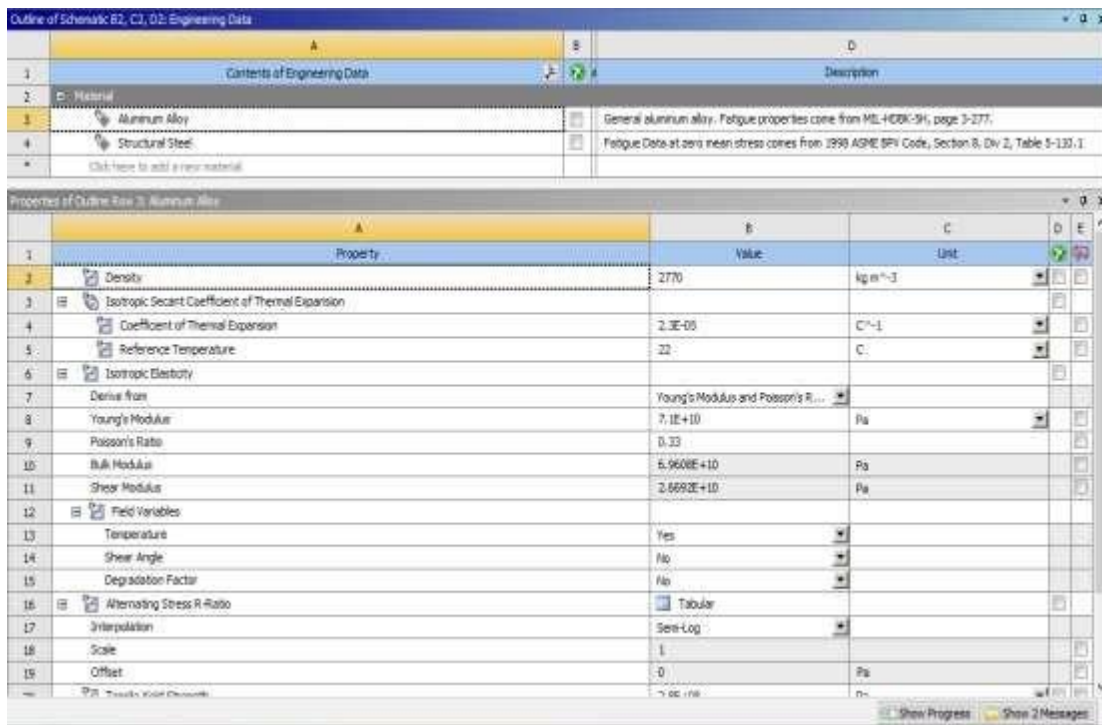

Figure 5. 4 Specifying A Material

### 5.5.3. Generating The Mesh

After the model is created in the design modeler window, you need to generate the mesh for the model in the mechanical window.

1. In the project schematic window, double-click on the model cell in the static structural analysis system; the mechanical window is displayed.
2. Select mesh in the tree outline to display the details of "mesh" window.

3. In the details of "mesh" window, expand the sizing node, if it is not already expanded. Also, notice that default is displayed in the element size edit box.

The element size edit box is used to specify the size of an element. The element size specified in this edit box is according to the size of the geometry. However, this edit box will not be visible when the

- On: proximity and
- On: proximity and curvature

Options are selected from the use advanced size function drop-down list. When default is displayed in the element size edit box, it indicates that a default value, based on the size of the geometry, is already specified by the software.

4. Choose the generate mesh tool from the mesh drop-down in the mesh contextual toolbar; the mesh is generated.



**Figure 5. 5 Mesh Generated With Default Mesh Controls**

5. Expand the statistics node in the details of "mesh" window to display the total number of elements created. On doing so, you will find that the total number of elements.

#### **5.5.4. Specifying The Boundary Conditions**

After you mesh the model, it is required to specify the boundary and loading conditions.

1. In the mechanical window, select the static structural node from the tree outline; the details of "static structural" window is displayed along with the environment contextual toolbar.

2. Choose the fixed support tool from the supports drop-down in the environment contextual toolbar; fixed support is added under the static structural node. Also, the details of “static structural” window is displayed
3. Click on the geometry selection box to display the apply and cancel buttons
4. Choose the face tool from the select toolbar to enable selection of faces.

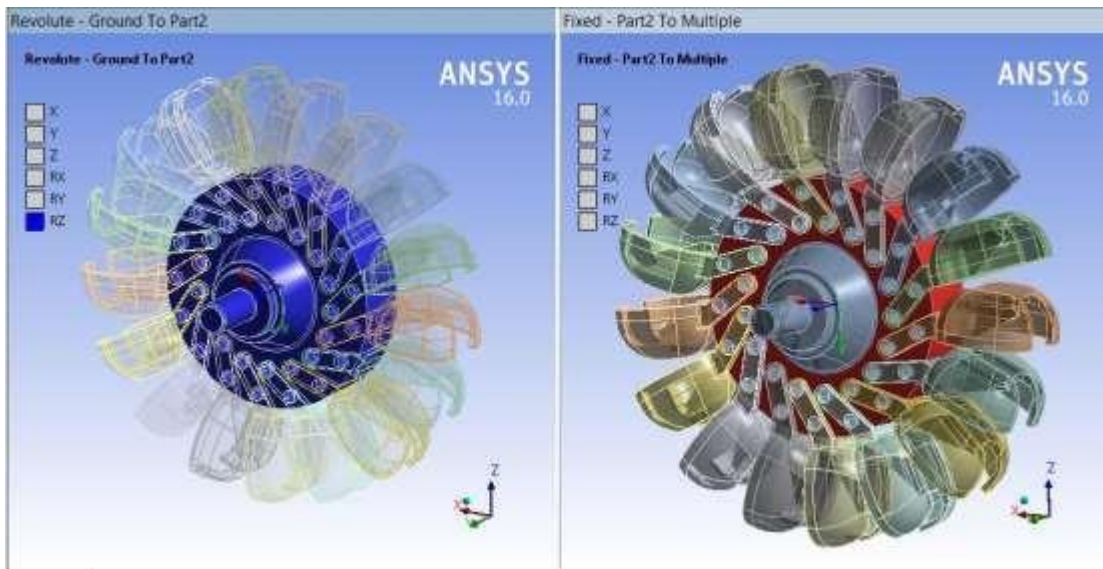

**Figure 5. 6 Choosing The Revolve Connection Tool Fixed Connection Tool**

5. click on body to body connection and select cylindrical body to body connection type. select required face in mobile and reference in details of cylindrical body to body connection type.
6. click on body to ground connection and select revolve body to ground connection type. select required face in mobile and reference in details of cylindrical body to ground connection type.
7. Select faces on the model. Next, choose the apply button in the geometry selection box; the selected faces turn purple indicating that fixed support is applied
8. Click on the geometry selection box to display the apply and cancel buttons, if they are not already displayed.
9. Next, select the circular face on the right of the model, as shown in figure.
10. Choose the apply button from the geometry selection box; the cylindrical face turns red indicating that the force load is applied.
11. In the details of “pressure” window, expand the Definition node, if it is not already expanded.

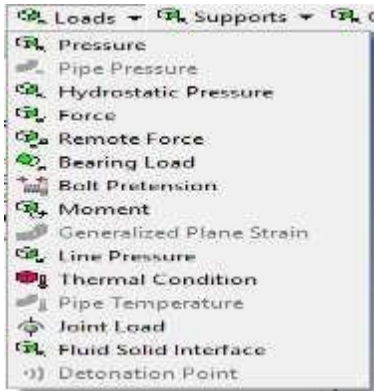

**Figure 5. 7 The Loads Drop-Down**

12. Select vector from the define by drop-down list, if it is not already selected.
  13. In the details of “force” window, click on the right arrow next to the magnitude edit box; a fly-out is displayed.
  14. Choose constant from the fly out, if it is not already chosen, as shown in figure. The constant option is chosen when the force applied remains constant with respect to time,
  15. In the magnitude edit box, enter number.
  16. Click on the direction selection box to display the apply and cancel buttons.
- As the application of force under consideration is vertically downward, you need to define the direction by selecting edges for the force vector.
17. Select any vertical edge on the model, as shown in figure 949, to specify the direction of force application
  18. Next, choose the apply button from the direction selection box; a downward force is specified for the analysis. After you have selected the edge for specifying the direction, you can flip the direction
  19. Specified by choosing the flip button available in the graphics screen.

### **5.5.7. Solving The Fea Model And Analyzing The Results**

After the boundary and load conditions are specified for the model, you need to solve the analysis. After solving, you will get the total and directional deformations due to the given condition. Also, you will get equivalent stress, maximum principal, and minimum principal stresses.

1. Select the solution node in the tree outline; the solution contextual toolbar is displayed. Also, the details of “solution” window is displayed.

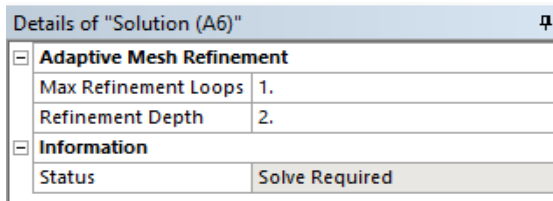

Figure 5. 8 The Details Of Solution Window

2. Choose the total tool from the deformation drop-down of the solution contextual toolbar; total deformation is added under the solution node.

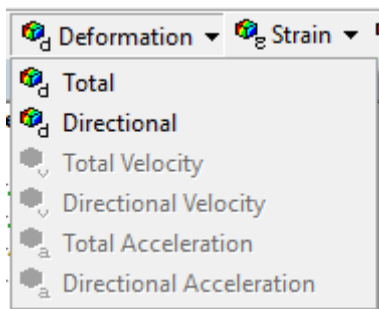

Figure 5. 9 Choosing The Total Tool From The Deformation Drop Down

3. Now, choose the directional tool from the deformation drop-down; directional deformation is added under the solution node.

4. Choose the equivalent (von-misses) tool from the stress drop-down in the solution contextual toolbar;

The equivalent or von-misses stress is the criteria by which the effect of all the directional stresses acting at a point is considered 1" his helps in finding out whether the model will fail or bear the stress at that particular point.

5. Choose the fatigue tool from the contact tool drop-down in the solution contextual toolbar

6. Again go to the fatigue tool from the solution and right click on it. Select life and damages for the model.

7. Choose the solve tool from the standard toolbar; the parameters are evaluated

8. In the tree outline, select total deformation to visualize the results; the deformed model is shown in the graphics screen

## 6. RESULT

First Saved	Friday, December 16, 2022
Last Saved	Friday, December 16, 2022
Product Version	2019 R3
Save Project Before Solution	No
Save Project After Solution	No



Figure 6. 1 Pelton wheel

### 6.1 Units

TABLE 1

Unit System	Metric (mm, kg, N, s, mV, mA) Degrees rad/s Celsius
Angle	Degrees
Rotational Velocity	rad/s
Temperature	Celsius

## 6.2 Model (B4, C4)

### 6.3.1 Geometry

**TABLE 2**  
**Model (B4, C4) > Geometry**

Object Name	Geometry
State	Fully Defined
<b>Definition</b>	
Source	C:\Users\Raksha B\Desktop\Steps\pelton.stp
Type	Step
Length Unit	Millimeters
Element Control	Program Controlled
Display Style	Body Color
<b>Bounding Box</b>	
Length X	66.92 mm
Length Y	323.8 mm
Length Z	322.67 mm
<b>Properties</b>	
Volume	2.3996e+006 mm <sup>3</sup>
Mass	18.837 kg
Scale Factor Value	1.
<b>Statistics</b>	
Bodies	19
Active Bodies	19
Nodes	95423
Elements	46543
Mesh Metric	None
<b>Update Options</b>	
Assign Default Material	No
<b>Basic Geometry Options</b>	
Solid Bodies	Yes
Surface Bodies	Yes
Line Bodies	No
Parameters	Independent
Parameter Key	ANS;DS
Attributes	No
Named Selections	No
Material Properties	No
<b>Advanced Geometry Options</b>	
Use Associativity	Yes
Coordinate Systems	No
Reader Mode Saves Updated File	No
Use Instances	Yes
Smart CAD Update	Yes
Compare Parts On Update	No
Analysis Type	3-D
Mixed Import Resolution	None
Clean Bodies On Import	No
Stitch Surfaces On Import	Program Tolerance
Decompose Disjoint Geometry	Yes



Enclosure and Symmetry Processing	Yes
-----------------------------------	-----

**TABLE 3**  
**Model (B4, C4) > Geometry > Parts**

Object Name	pelton-FreeParts PartBody.1	pelton-FreeParts PartBody.2	pelton-FreeParts PartBody.3	pelton-FreeParts PartBody.4	pelton-FreeParts PartBody.5	pelton-FreeParts PartBody.6	pelton-FreeParts PartBody.7	pelton-FreeParts PartBody.8	pelton-FreeParts PartBody.9	pelton-FreeParts PartBody.10	pelton-FreeParts PartBody.11
State	Meshed										
<b>Graphics Properties</b>											
Visible	Yes										
Transparency	1										
<b>Definition</b>											
Suppressed	No										
Stiffness Behavior	Flexible										
Coordinate System	Default Coordinate System										
Reference Temperature	By Environment										
Treatment	None										
<b>Material</b>											
Assignment	Structural Steel										
Nonlinear Effects	Yes										
Thermal Strain Effects	Yes										

Bounding Box											
Length X	66.92 mm										
Length Y	87.411 mm	86.716 mm	77.877 mm	61.004 mm	41.238 mm	36.682 mm	49.202 mm	69.397 mm	83.436 mm	87.411 mm	86.716 mm
Length Z	31.592 mm	44.131 mm	59.09 mm	77.595 mm	86.741 mm	87.689 mm	83.412 mm	70.28 mm	51.196 mm	31.592 mm	44.131 mm
Properties											
Volume	38301 mm <sup>3</sup>	38306 mm <sup>3</sup>	38298 mm <sup>3</sup>	38299 mm <sup>3</sup>	38308 mm <sup>3</sup>	38299 mm <sup>3</sup>	38307 mm <sup>3</sup>	38298 mm <sup>3</sup>		38301 mm <sup>3</sup>	38306 mm <sup>3</sup>
Mass	0.30066 kg	0.3007 kg	0.30064 kg	0.30065 kg	0.30072 kg	0.30065 kg	0.30071 kg	0.30064 kg		0.30066 kg	0.3007 kg
Centroid X	-8.1349e-006 mm	1.2666e-005 mm	9.9914e-005 mm	2.9773e-005 mm	1.1786e-004 mm	8.6542e-005 mm	1.7731e-006 mm	1.0029e-004 mm	4.0894e-005 mm	-8.1349e-006 mm	1.2668e-005 mm
Centroid Y	132.69 mm	129.35 mm	110.42 mm	78.17 mm	36.497 mm	-9.5862 mm	-54.507 mm	-92.854 mm	-120. mm	-132.69 mm	-129.35 mm
Centroid Z	-13.662 mm	32.539 mm	74.816 mm	108.07 mm	128.29 mm	133.04 mm	121.74 mm	95.749 mm	58.217 mm	13.662 mm	-32.539 mm
Moment of Inertia Ip1	103.22 kg·mm <sup>2</sup>	103.24 kg·mm <sup>2</sup>	103.21 kg·mm <sup>2</sup>		103.23 kg·mm <sup>2</sup>	103.21 kg·mm <sup>2</sup>	103.25 kg·mm <sup>2</sup>	103.21 kg·mm <sup>2</sup>		103.22 kg·mm <sup>2</sup>	103.24 kg·mm <sup>2</sup>
Moment of Inertia Ip2	144.6 kg·mm <sup>2</sup>	144.64 kg·mm <sup>2</sup>	144.63 kg·mm <sup>2</sup>	217.34 kg·mm <sup>2</sup>	217.36 kg·mm <sup>2</sup>	217.31 kg·mm <sup>2</sup>	217.39 kg·mm <sup>2</sup>	144.63 kg·mm <sup>2</sup>		144.6 kg·mm <sup>2</sup>	144.64 kg·mm <sup>2</sup>
Moment of Inertia Ip3	217.32 kg·mm <sup>2</sup>	217.37 kg·mm <sup>2</sup>	217.34 kg·mm <sup>2</sup>	144.63 kg·mm <sup>2</sup>		144.59 kg·mm <sup>2</sup>	144.65 kg·mm <sup>2</sup>	217.34 kg·mm <sup>2</sup>	217.33 kg·mm <sup>2</sup>	217.32 kg·mm <sup>2</sup>	217.37 kg·mm <sup>2</sup>
Statistics											
Nodes	5142	5147	4944	5223	5143	5168	5162	5149	5309	5208	5129
Elements	2540	2555	2421	2606	2555	2577	2581	2556	2638	2590	2544
Mesh Metric	None										

**TABLE 4**  
Model (B4, C4) > Geometry > Parts

Object Name	pelton-FreeParts PartBody. 12	pelton-FreeParts PartBody. 13	pelton-FreeParts PartBody. 14	pelton-FreeParts PartBody. 15	pelton-FreeParts PartBody. 16	pelton-FreeParts PartBody. 17	pelton-FreeParts PartBody. 18	pelton-FreeParts PartBody. 2
State	Meshed							
<b>Graphics Properties</b>								
Visible	Yes							
Transparency	1							
<b>Definition</b>								
Suppressed	No							
Stiffness Behavior	Flexible							
Coordinate System	Default Coordinate System							
Reference Temperature	By Environment							
Treatment	None							
<b>Material</b>								
Assignment	Structural Steel							
Nonlinear Effects	Yes							
Thermal Strain Effects	Yes							
<b>Bounding Box</b>								
Length X	66.92 mm							60. mm
Length Y	77.877 mm	61.004 mm	41.238 mm	36.682 mm	49.202 mm	69.397 mm	83.436 mm	200. mm
Length Z	59.09 mm	77.595 mm	86.741 mm	87.689 mm	83.412 mm	70.28 mm	51.196 mm	200. mm
<b>Properties</b>								
Volume	38298 mm <sup>3</sup>	38299 mm <sup>3</sup>	38308 mm <sup>3</sup>	38299 mm <sup>3</sup>	38307 mm <sup>3</sup>	38298 mm <sup>3</sup>		1.7102e+006 mm <sup>3</sup>
Mass	0.30064 kg	0.30065 kg	0.30072 kg	0.30065 kg	0.30071 kg	0.30064 kg		13.425 kg

Centroid X	9.9913e-005 mm	2.9774e-005 mm	1.1786e-004 mm	8.6542e-005 mm	1.7731e-006 mm	1.0029e-004 mm	4.0894e-005 mm	8.8492e-016 mm
Centroid Y	-110.42 mm	-78.17 mm	-36.497 mm	9.5862 mm	54.507 mm	92.854 mm	120. mm	1.0749e-015 mm
Centroid Z	-74.816 mm	-108.07 mm	-128.29 mm	-133.04 mm	-121.74 mm	-95.749 mm	-58.217 mm	0. mm
Moment of Inertia Ip1	103.21 kg·mm <sup>2</sup>		103.23 kg·mm <sup>2</sup>	103.21 kg·mm <sup>2</sup>	103.25 kg·mm <sup>2</sup>	103.21 kg·mm <sup>2</sup>		72849 kg·mm <sup>2</sup>
Moment of Inertia Ip2	144.63 kg·mm <sup>2</sup>	217.34 kg·mm <sup>2</sup>	217.36 kg·mm <sup>2</sup>	217.31 kg·mm <sup>2</sup>	217.39 kg·mm <sup>2</sup>	144.63 kg·mm <sup>2</sup>		40452 kg·mm <sup>2</sup>
Moment of Inertia Ip3	217.34 kg·mm <sup>2</sup>	144.63 kg·mm <sup>2</sup>		144.59 kg·mm <sup>2</sup>	144.65 kg·mm <sup>2</sup>	217.34 kg·mm <sup>2</sup>	217.33 kg·mm <sup>2</sup>	40452 kg·mm <sup>2</sup>
<b>Statistics</b>								
Nodes	4960	5261	5173	5118	5062	5153	5299	2673
Elements	2440	2631	2581	2534	2509	2560	2633	492
Mesh Metric	None							

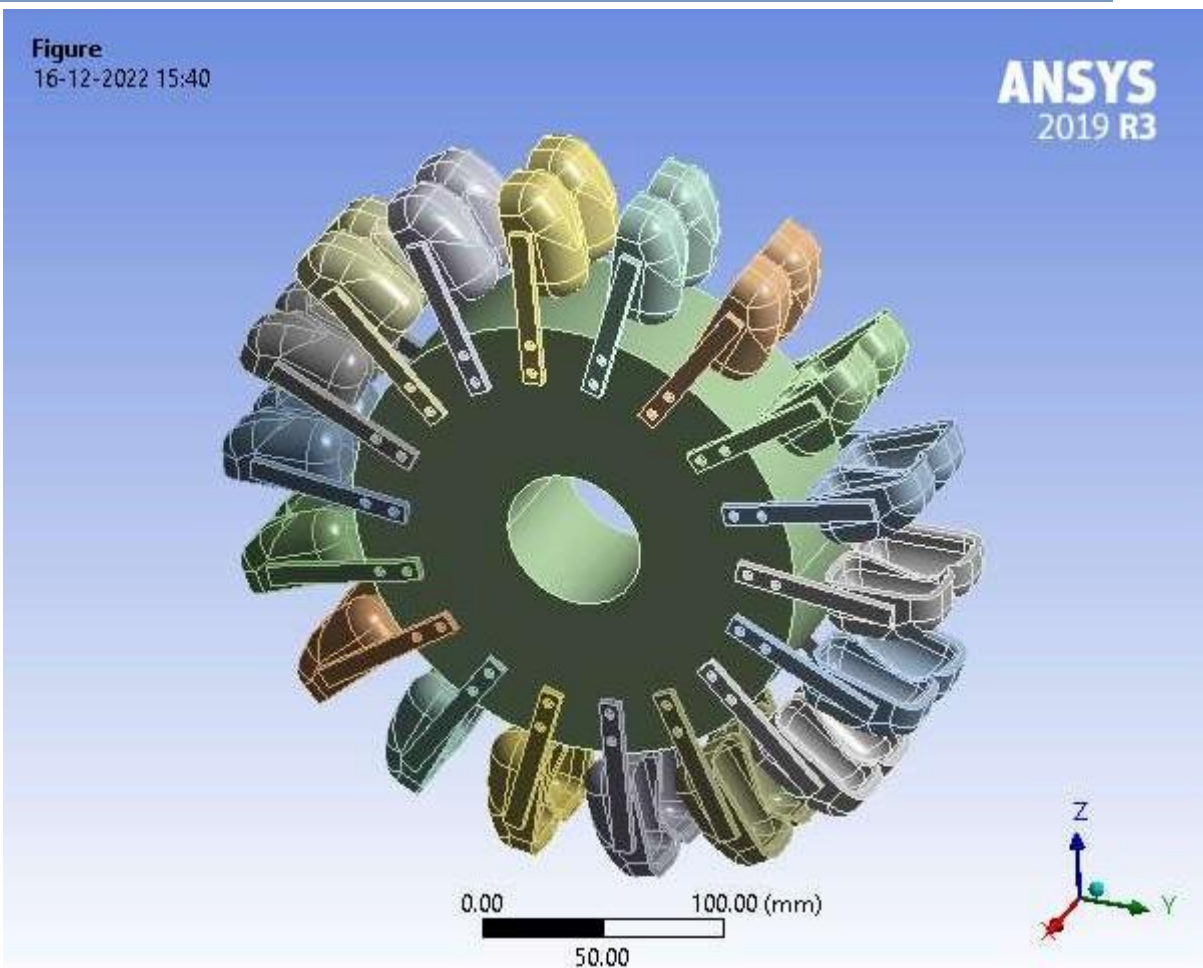

Figure 6. 2 Model (B4, C4)

TABLE 5  
Model (B4, C4) > Materials

Object Name	Materials
State	Fully Defined
<b>Statistics</b>	
Materials	1
Material Assignments	0

6.3.2 Coordinate Systems

TABLE 6  
Model (B4, C4) > Coordinate Systems > Coordinate System

Object Name	Global Coordinate System
State	Fully Defined
<b>Definition</b>	
Type	Cartesian
Coordinate System ID	0.
<b>Origin</b>	
Origin X	0. mm
Origin Y	0. mm
Origin Z	0. mm
<b>Directional Vectors</b>	
X Axis Data	[ 1. 0. 0. ]
Y Axis Data	[ 0. 1. 0. ]
Z Axis Data	[ 0. 0. 1. ]

6.3.3 Connections

TABLE 7  
Model (B4, C4) > Connections

Object Name	Connections
State	Fully Defined
<b>Auto Detection</b>	
Generate Automatic Connection On Refresh	Yes
<b>Transparency</b>	
Enabled	Yes

TABLE 8  
Model (B4, C4) > Connections > Contacts

Object Name	Contacts
State	Fully Defined
<b>Definition</b>	
Connection Type	Contact
<b>Scope</b>	
Scoping Method	Geometry Selection
Geometry	All Bodies
<b>Auto Detection</b>	
Tolerance Type	Slider
Tolerance Slider	0.
Tolerance Value	1.155 mm
Use Range	No

Face/Face	Yes
Face-Face Angle Tolerance	75. °
Face Overlap Tolerance	Off
Cylindrical Faces	Include
Face/Edge	No
Edge/Edge	No
Priority	Include All
Group By	Bodies
Search Across	Bodies
<b>Statistics</b>	
Connections	18
Active Connections	18

**TABLE 9**  
**Model (B4, C4) > Connections > Contacts > Contact Regions**

Object Name	Contact Region 1	Contact Region 2	Contact Region 3	Contact Region 4	Contact Region 5	Contact Region 6	Contact Region 7	Contact Region 8	Contact Region 9	Contact Region 10	Contact Region 11
State	Fully Defined										
<b>Scope</b>											
Scoping Method	Geometry Selection										
Contact	2 Faces										
Target	2 Faces										
Contact Bodies	pelton-FreeParts Part Body.1	pelton-FreeParts Part Body.2	pelton-FreeParts Part Body.3	pelton-FreeParts Part Body.4	pelton-FreeParts Part Body.5	pelton-FreeParts Part Body.6	pelton-FreeParts Part Body.7	pelton-FreeParts Part Body.8	pelton-FreeParts Part Body.9	pelton-FreeParts Part Body.10	pelton-FreeParts Part Body.11
Target Bodies	pelton-FreeParts Body.2										
Protected	No										
<b>Definition</b>											
Type	Bonded										
Scope Mode	Automatic										
Behavior	Program Controlled										

Tri m Co nta ct		Program Controlled
Tri m Tol era nce	1.155 mm	
Sup pre sse d		No
<b>Advanced</b>		
For mul atio n		Program Controlled
Sm all Slid ing		Program Controlled
Det ecti on		Program Controlled
Met hod		
Pen etra tion Tol era nce		Program Controlled
Ela stic Slip Tol era nce		Program Controlled
Nor mal Stiff nes s		Program Controlled
Upd ate Stiff nes s		Program Controlled
Pin ball Re gio n		Program Controlled
<b>Geometric Modification</b>		

Contact Geometry Correction	None
Target Geometry Correction	None

**TABLE 10**  
**Model (B4, C4) > Connections > Contacts > Contact Regions**

Object Name	Contact Region 12	Contact Region 13	Contact Region 14	Contact Region 15	Contact Region 16	Contact Region 17	Contact Region 18
State	Fully Defined						
<b>Scope</b>							
Scoping	Geometry Selection						
Method							
Contact	2 Faces						
Target	2 Faces						
Contact Bodies	pelton-FreeParts PartBody.12	pelton-FreeParts PartBody.13	pelton-FreeParts PartBody.14	pelton-FreeParts PartBody.15	pelton-FreeParts PartBody.16	pelton-FreeParts PartBody.17	pelton-FreeParts PartBody.18
Target Bodies	pelton-FreeParts Body.2						
Protected	No						
<b>Definition</b>							
Type	Bonded						
Scope Mode	Automatic						
Behavior	Program Controlled						
Trim Contact	Program Controlled						
Trim Tolerance	1.155 mm						
Suppressed	No						



Advanced	
Formulation	Program Controlled
Small Sliding	Program Controlled
Detection Method	Program Controlled
Penetration Tolerance	Program Controlled
Elastic Slip Tolerance	Program Controlled
Normal Stiffness	Program Controlled
Update	Program Controlled
Stiffness	
Pinball Region	Program Controlled
Geometric Modification	
Contact Geometry Correction	None
Target Geometry Correction	None

### 6.3.4 Mesh

**TABLE 11**  
**Model (B4, C4) > Mesh**

Object Name	Mesh
State	Solved
Display	
Display Style	Use Geometry Setting
Defaults	
Physics Preference	Mechanical

Element Order	Program Controlled
Element Size	Default
<b>Sizing</b>	
Use Adaptive Sizing	Yes
Resolution	Default (2)
Mesh Defeaturing	Yes
Defeature Size	Default
Transition	Fast
Span Angle Center	Coarse
Initial Size Seed	Assembly
Bounding Box Diagonal	461.99 mm
Average Surface Area	137.93 mm <sup>2</sup>
Minimum Edge Length	1.6798e-003 mm
<b>Quality</b>	
Check Mesh Quality	Yes, Errors
Error Limits	Aggressive Mechanical
Target Quality	Default (0.050000)
Smoothing	Medium
Mesh Metric	None
<b>Inflation</b>	
Use Automatic Inflation	None
Inflation Option	Smooth Transition
Transition Ratio	0.272
Maximum Layers	5
Growth Rate	1.2
Inflation Algorithm	Pre
View Advanced Options	No
<b>Advanced</b>	
Number of CPUs for Parallel Part Meshing	Program Controlled
Straight Sided Elements	No
Rigid Body Behavior	Dimensionally Reduced
Triangle Surface Mesher	Program Controlled
Topology Checking	Yes
Pinch Tolerance	Please Define
Generate Pinch on Refresh	No
<b>Statistics</b>	
Nodes	95423
Elements	46543

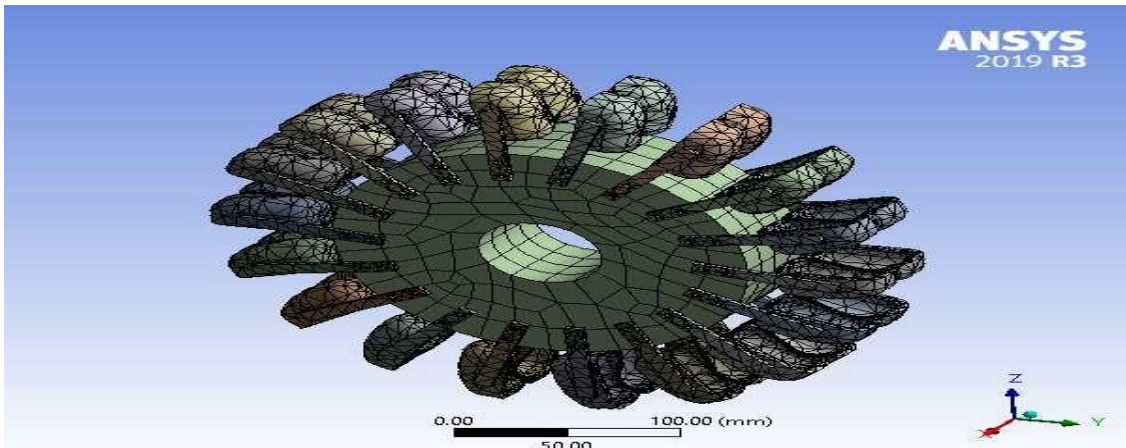

Figure 6. 3 Model (B4, C4) > Mesh >

### 6.3 Modal (B5)

**TABLE 12**  
Model (B4, C4) > Analysis

Object Name	Modal (B5)
State	Solved
<b>Definition</b>	
Physics Type	Structural
Analysis Type	Modal
Solver Target	Mechanical APDL
<b>Options</b>	
Environment Temperature	22. °C
Generate Input Only	No

**TABLE 13**  
Model (B4, C4) > Modal (B5) > Initial Condition

Object Name	Pre-Stress (None)
State	Fully Defined
<b>Definition</b>	
Pre-Stress Environment	None

**TABLE 14**  
Model (B4, C4) > Modal (B5) > Analysis Settings

Object Name	Analysis Settings
State	Fully Defined
<b>Options</b>	
Max Modes to Find	8
Limit Search to Range	No
<b>Solver Controls</b>	
Damped	No
Solver Type	Program Controlled
<b>Rotordynamics Controls</b>	
Coriolis Effect	Off
Campbell Diagram	Off

Output Controls	
Stress	No
Surface Stress	No
Back Stress	No
Strain	No
Contact Data	Yes
Nodal Forces	No
Calculate Reactions	No
General Miscellaneous	No
Result File Compression	Program Controlled
Analysis Data Management	
Solver Files Directory	C:\Users\Raksha B\AppData\Local\Temp\WB_DESKTOP-LAGUD7Q_Raksha B_3848_2\unsaved_project_files\dp0\SYS\MECH\
Future Analysis	None
Scratch Solver Files Directory	
Save MAPDL db	No
Contact Summary	Program Controlled
Delete Unneeded Files	Yes
Solver Units	Active System
Solver Unit System	nmm

**TABLE 15**  
**Model (B4, C4) > Modal (B5) > Loads**

Object Name	<i>Fixed Support</i>
State	Fully Defined
<b>Scope</b>	
Scoping Method	Geometry Selection
Geometry	2 Faces
<b>Definition</b>	
Type	Fixed Support
Suppressed	No

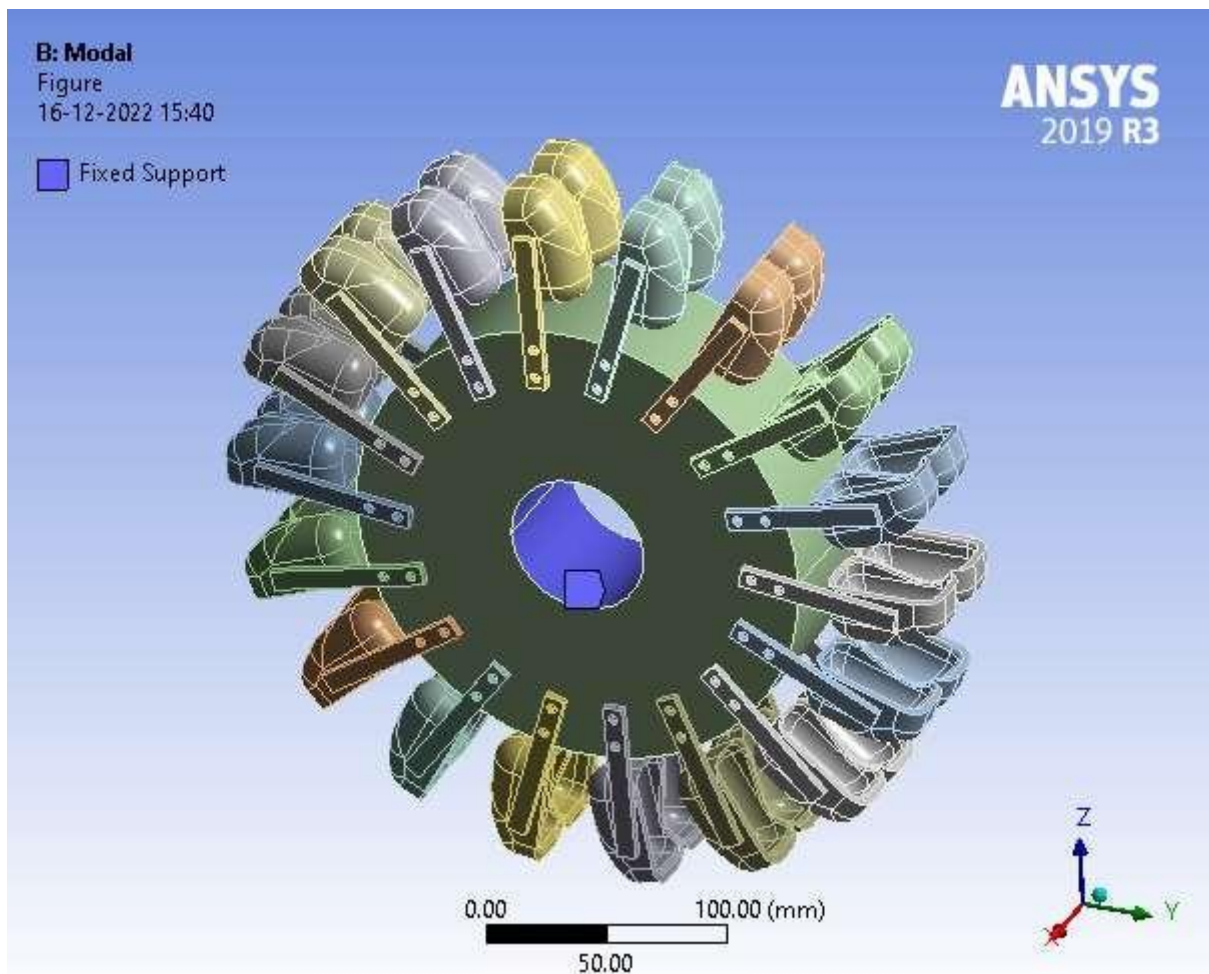

**Figure 6. 4 Model (B4, C4) > Modal (B5) > Figure**

## 6.4 Solution (B6)

**TABLE 16**  
**Model (B4, C4) > Modal (B5) > Solution**

Object Name	<i>Solution (B6)</i>
State	Solved
<b>Adaptive Mesh Refinement</b>	

Max Refinement Loops	1.
Refinement Depth	2.
<b>Information</b>	
Status	Done
MAPDL Elapsed Time	33. s
MAPDL Memory Used	2.5576 GB
MAPDL Result File Size	31.875 MB
<b>Post Processing</b>	
Beam Section Results	No

The following bar chart indicates the frequency at each calculated mode.

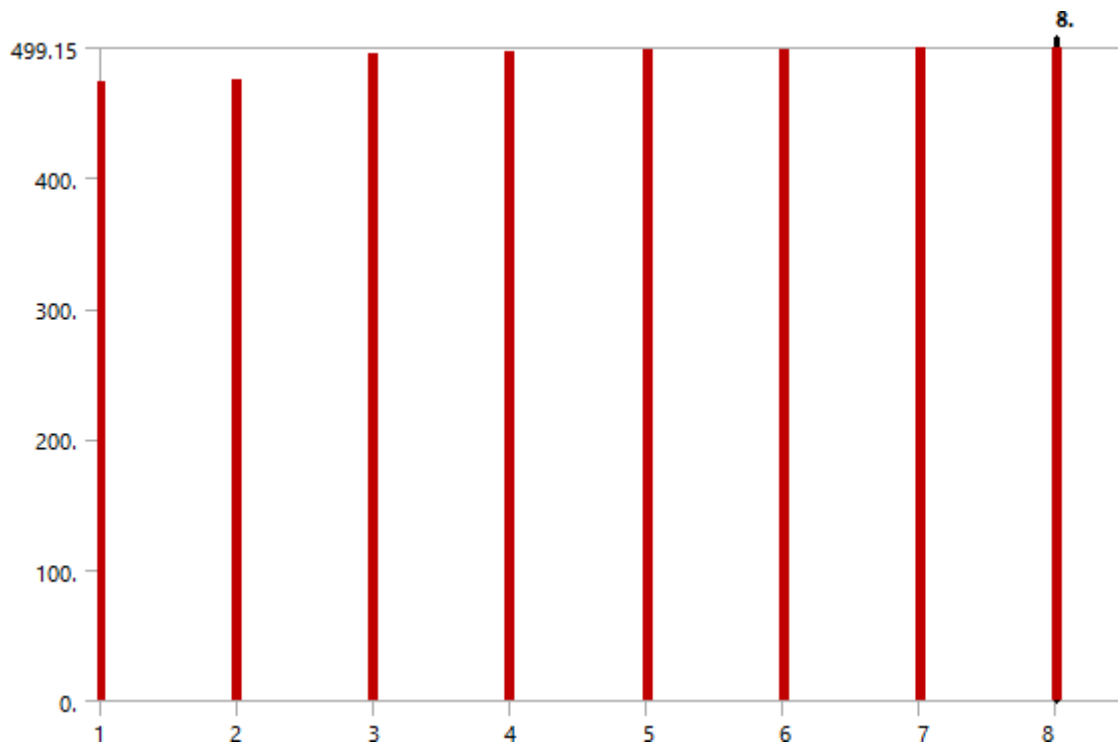

**Figure 6. 5 Model (B4, C4) > Modal (B5) > Solution (B6) TABLE 17**  
**Model (B4, C4) > Modal (B5) > Solution (B6)**

Mode	Frequency [Hz]
1.	472.56
2.	474.25
3.	494.62
4.	496.3
5.	497.32
6.	497.95
7.	498.73
8.	499.15

**TABLE 18**  
**Model (B4, C4) > Modal (B5) > Solution (B6) > Solution Information**

Object Name	Solution Information
State	Solved
<b>Solution Information</b>	
Solution Output	Solver Output
Newton-Raphson Residuals	0
Identify Element Violations	0
Update Interval	2.5 s
Display Points	All
<b>FE Connection Visibility</b>	
Activate Visibility	Yes
Display	All FE Connectors
Draw Connections Attached To	All Nodes
Line Color	Connection Type
Visible on Results	No
Line Thickness	Single
Display Type	Lines

**TABLE 19**  
**Model (B4, C4) > Modal (B5) > Solution (B6) > Results**

Object Name	Total Deformation 1	Total Deformation 2	Total Deformation 3	Total Deformation 4	Total Deformation 5	Total Deformation 6	Total Deformation 7	Total Deformation 8
State	Solved							
<b>Scope</b>								
Scoping Method	Geometry Selection							
Geometry	All Bodies							
<b>Definition</b>								
Type	Total Deformation							
Mode	1.	2.	3.	4.	5.	6.	7.	8.
Identifier								
Suppressed	No							
<b>Results</b>								
Minimum	0. mm							
Maximum	96.77 mm	96.805 mm	83.785 mm	75.219 mm	52.634 mm	63.526 mm	65.705 mm	59.933 mm
Average	2.8793 mm	2.8978 mm	6.3813 mm	6.9006 mm	7.112 mm	5.6396 mm	6.1504 mm	6.8932 mm
Minimum Occurs On	pelton-FreeParts Body.2							
Maximum Occurs On	pelton-FreeParts PartBody.1	pelton-FreeParts PartBody.10	pelton-FreeParts PartBody.8	pelton-FreeParts PartBody.17	pelton-FreeParts PartBody.2	pelton-FreeParts PartBody.7	pelton-FreeParts PartBody.7	pelton-FreeParts PartBody.3
<b>Information</b>								

Frequency	472.56 Hz	474.25 Hz	494.62 Hz	496.3 Hz	497.32 Hz	497.95 Hz	498.73 Hz	499.15 Hz
-----------	-----------	-----------	-----------	----------	-----------	-----------	-----------	-----------

**TABLE 20**  
**Model (B4, C4) > Modal (B5) > Solution (B6) > Total Deformation**

Mode	Frequency [Hz]
1.	472.56
2.	474.25
3.	494.62
4.	496.3
5.	497.32
6.	497.95
7.	498.73
8.	499.15

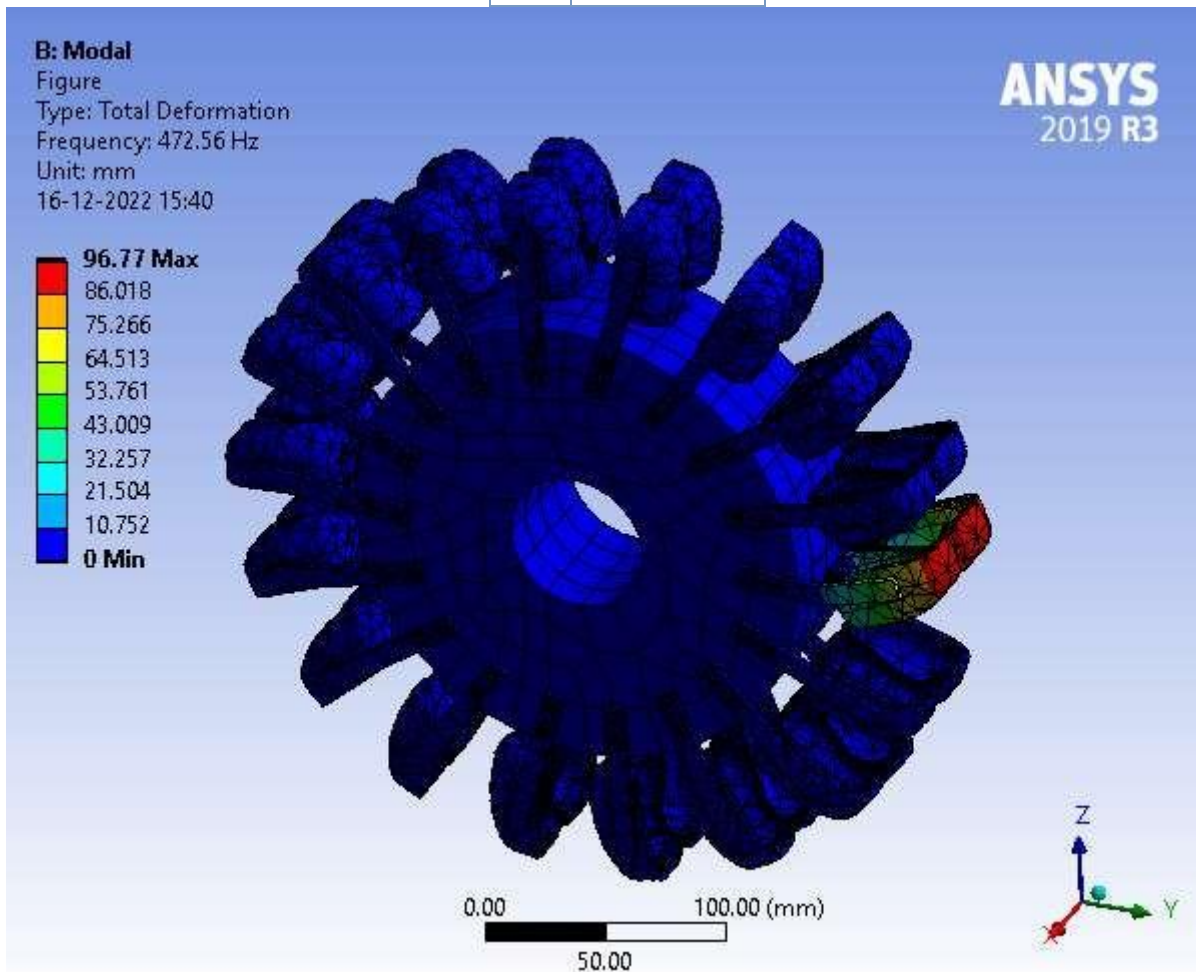

**Figure 6. 6 Model (B4, C4) > Modal (B5) > Solution (B6) > Total Deformation > Figure**

**TABLE 21**  
**Model (B4, C4) > Modal (B5) > Solution (B6) > Total Deformation 2**

Mode	Frequency [Hz]
1.	472.56



2.	474.25
3.	494.62
4.	496.3
5.	497.32
6.	497.95
7.	498.73
8.	499.15

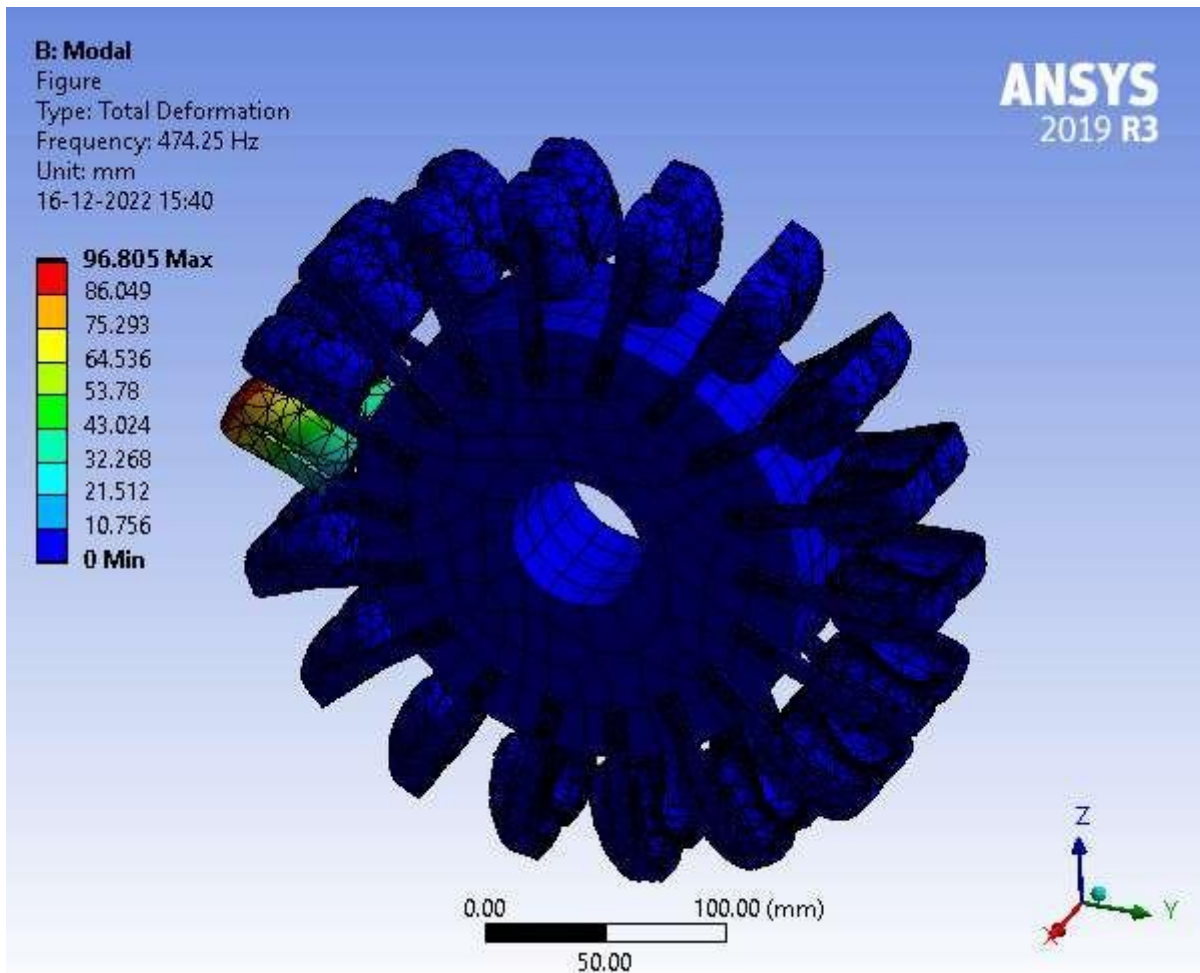

Figure 6. 7 Model (B4, C4) > Modal (B5) > Solution (B6) > Total Deformation 2 > Figure

TABLE 22

Model (B4, C4) > Modal (B5) > Solution (B6) > Total Deformation 3

Mode	Frequency [Hz]
1.	472.56
2.	474.25
3.	494.62
4.	496.3
5.	497.32
6.	497.95
7.	498.73

8.	499.15
----	--------

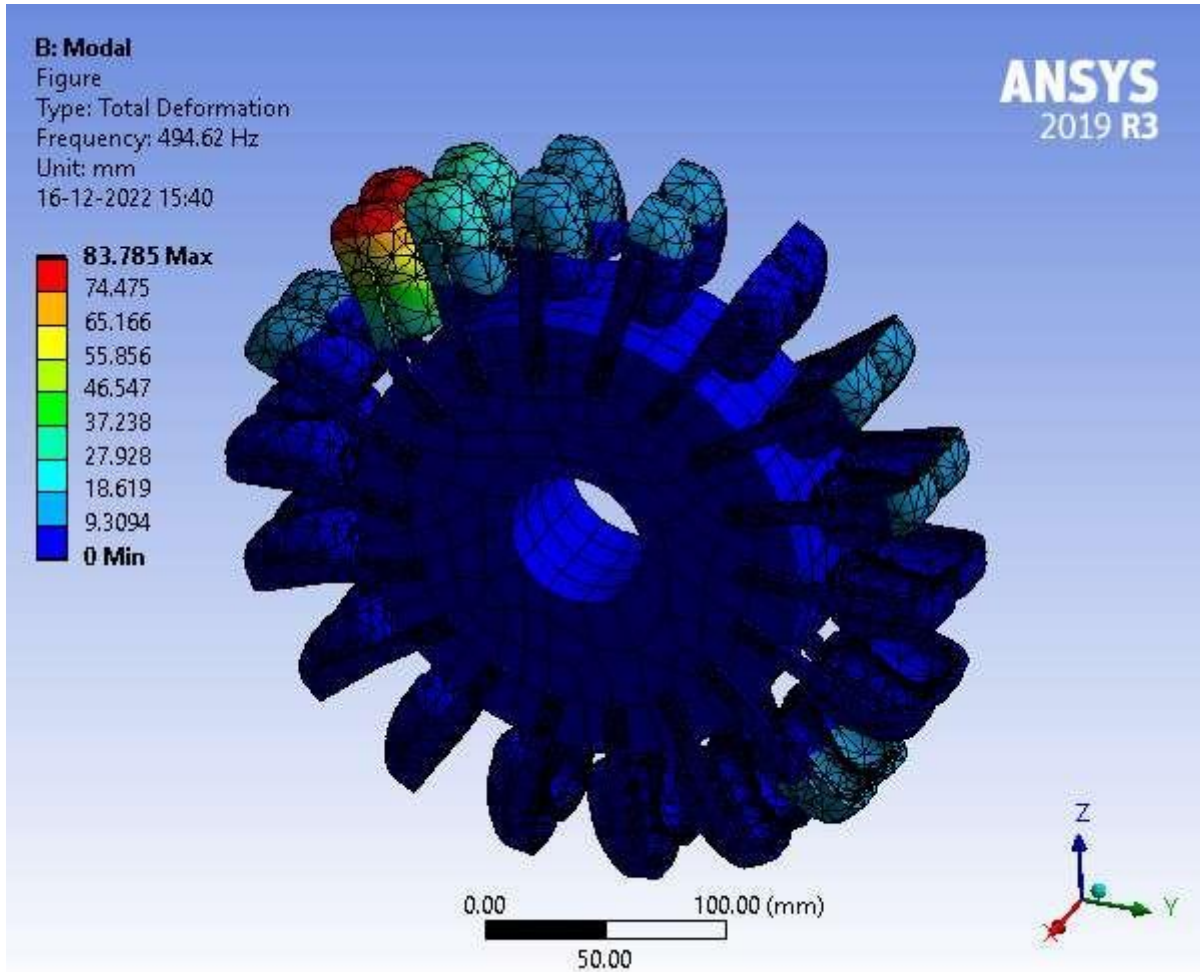

Figure 6. 8 Model (B4, C4) > Modal (B5) > Solution (B6) > Total Deformation 3 > Figure

**TABLE 23**  
 Model (B4, C4) > Modal (B5) > Solution (B6) > Total Deformation 4

Mode	Frequency [Hz]
1.	472.56
2.	474.25
3.	494.62
4.	496.3
5.	497.32
6.	497.95
7.	498.73
8.	499.15

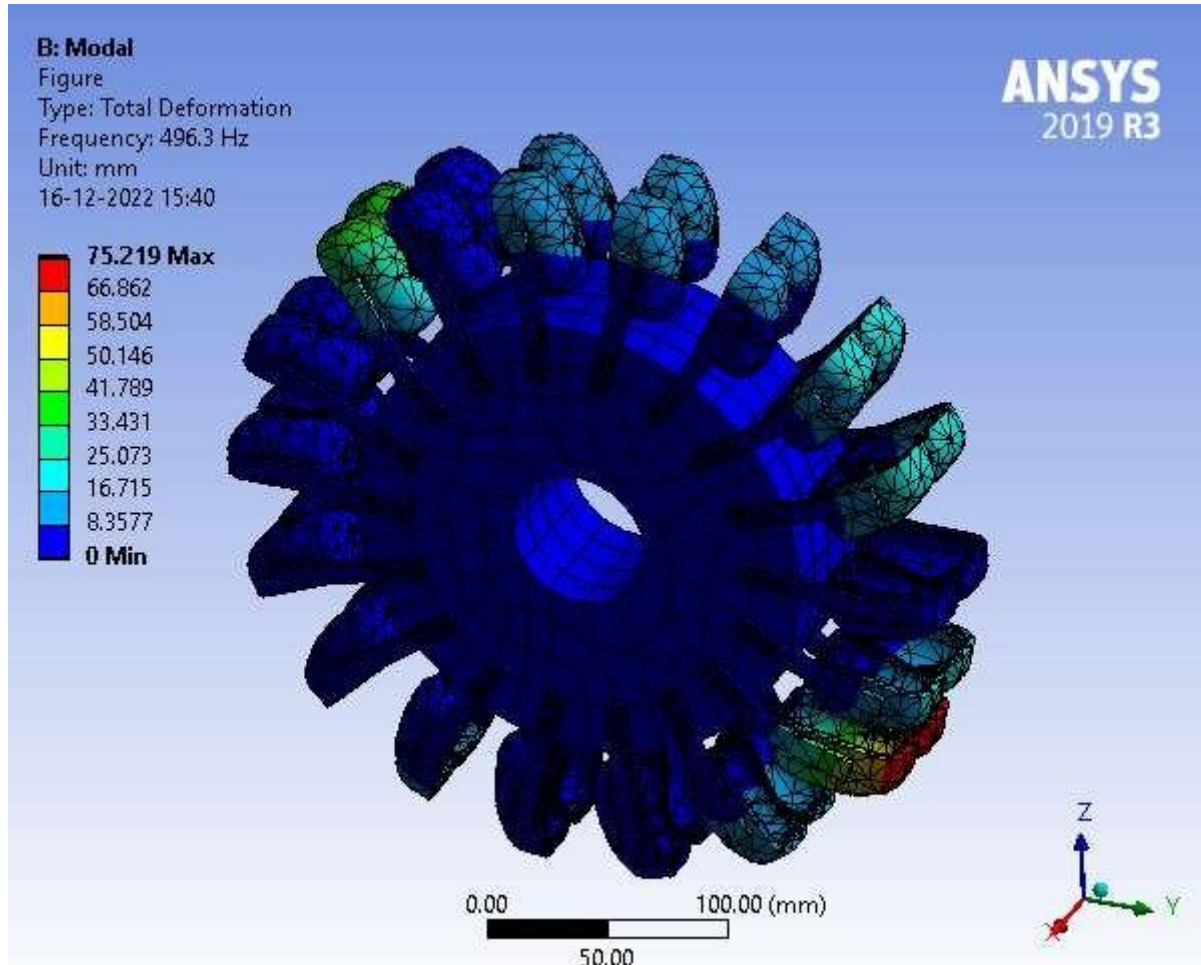

Figure 6. 9 Model (B4, C4) > Modal (B5) > Solution (B6) > Total Deformation 4 > Figure

**TABLE 24**  
 Model (B4, C4) > Modal (B5) > Solution (B6) > Total Deformation 5

Mode	Frequency [Hz]
1.	472.56
2.	474.25
3.	494.62
4.	496.3
5.	497.32
6.	497.95
7.	498.73
8.	499.15

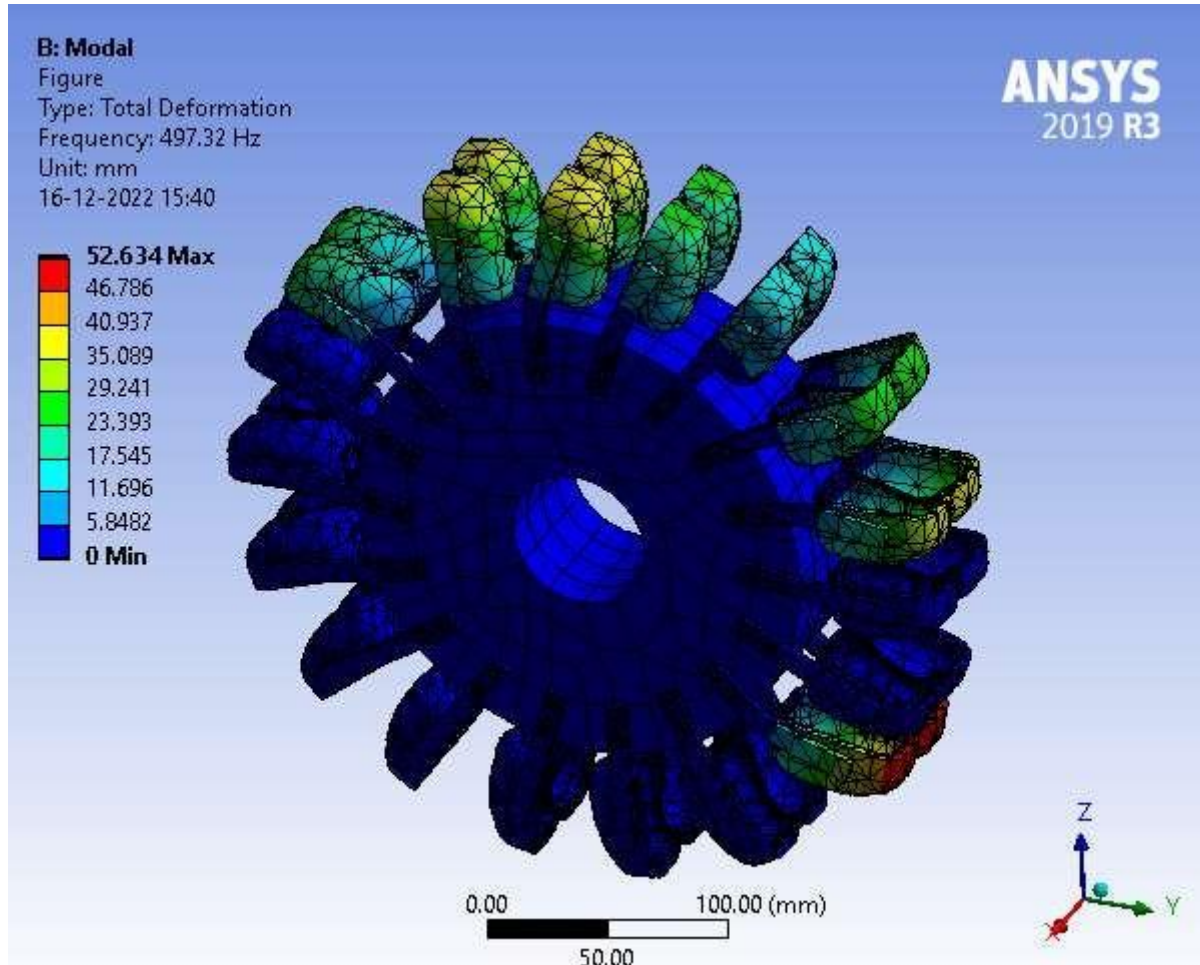

Figure 6. 10 Model (B4, C4) > Modal (B5) > Solution (B6) > Total Deformation 5 > Figure

TABLE 25  
 Model (B4, C4) > Modal (B5) > Solution (B6) > Total Deformation 6

Mode	Frequency [Hz]
1.	472.56
2.	474.25
3.	494.62
4.	496.3
5.	497.32
6.	497.95
7.	498.73
8.	499.15

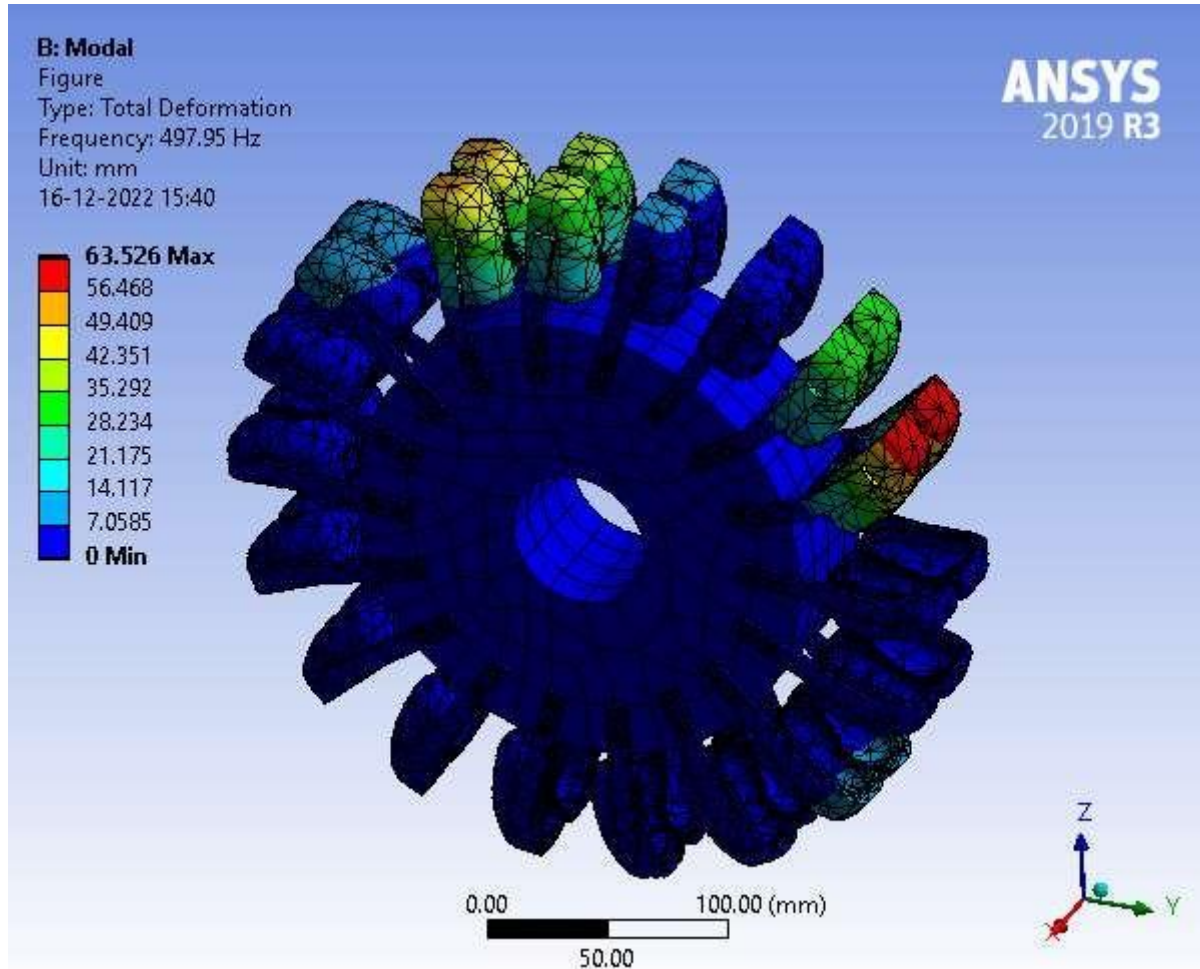

Figure 6. 11 Model (B4, C4) > Modal (B5) > Solution (B6) > Total Deformation 6 > Figure

TABLE 26  
 Model (B4, C4) > Modal (B5) > Solution (B6) > Total Deformation 7

Mode	Frequency [Hz]
1.	472.56
2.	474.25
3.	494.62
4.	496.3
5.	497.32
6.	497.95
7.	498.73
8.	499.15

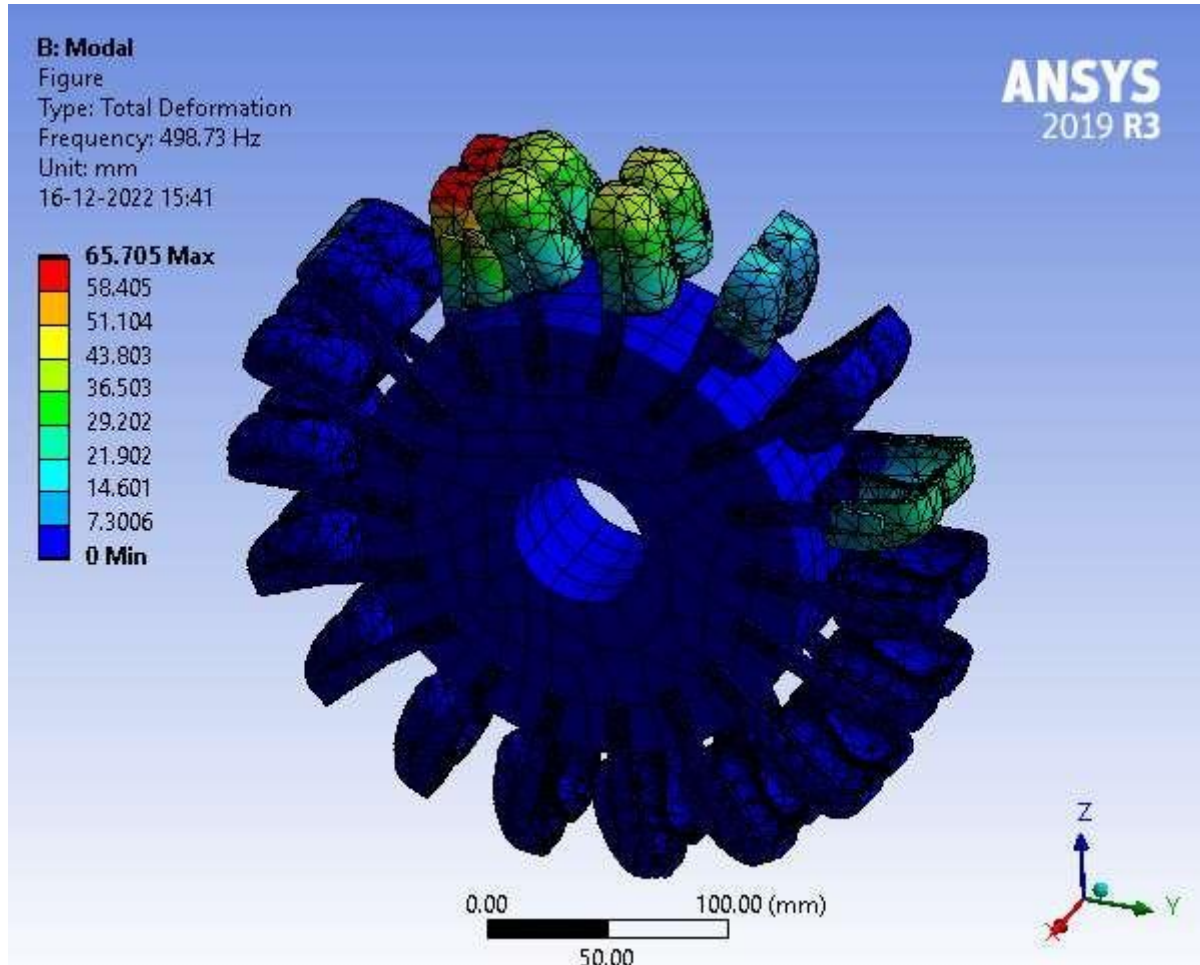

Figure 6. 12 Model (B4, C4) > Modal (B5) > Solution (B6) > Total Deformation 7 > Figure

TABLE 27  
 Model (B4, C4) > Modal (B5) > Solution (B6) > Total Deformation 8

Mode	Frequency [Hz]
1.	472.56
2.	474.25
3.	494.62
4.	496.3
5.	497.32
6.	497.95
7.	498.73
8.	499.15

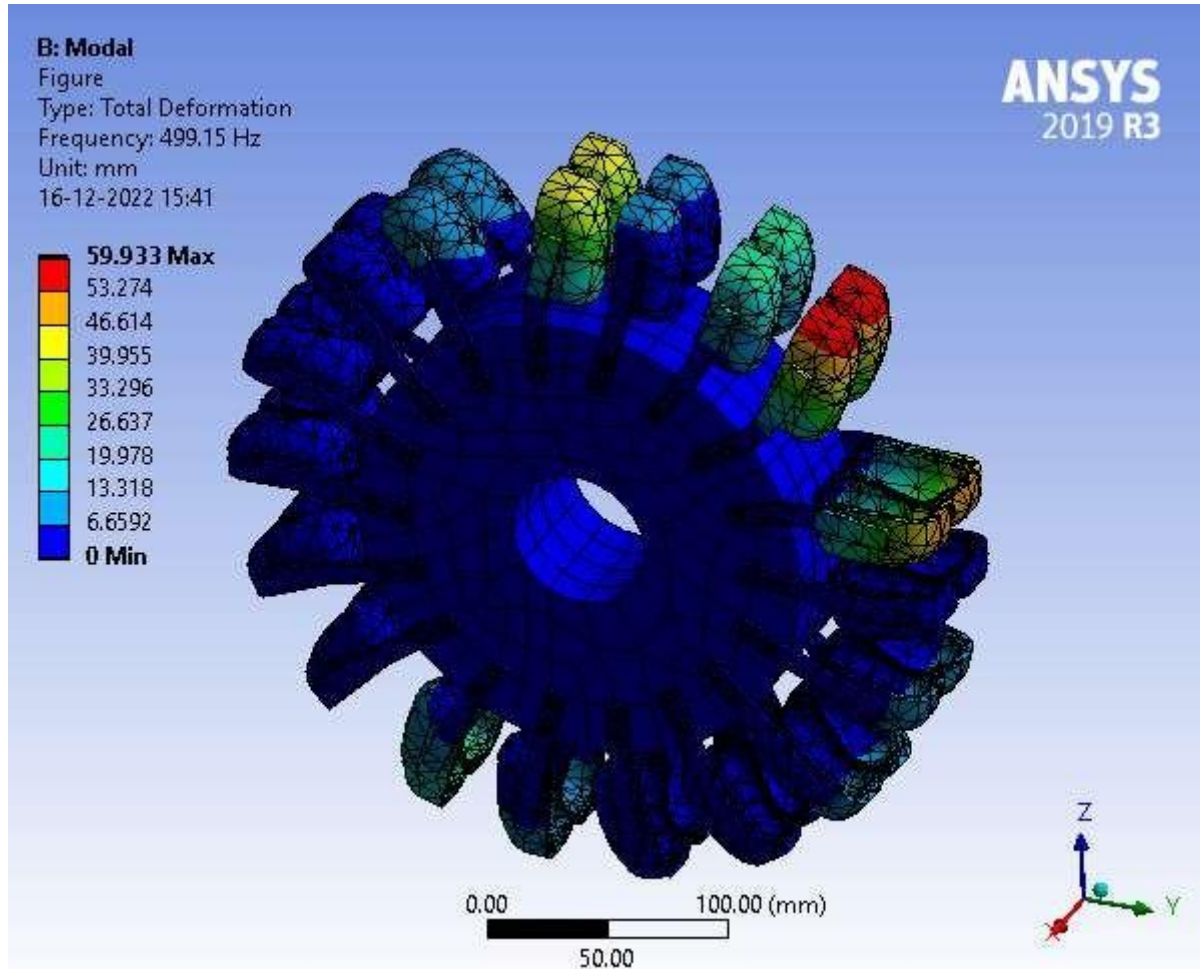

Figure 6. 13 Model (B4, C4) > Modal (B5) > Solution (B6) > Total Deformation 8 > Figure

## 6.5 Static Structural (C5)

**TABLE 28**  
Model (B4, C4) > Analysis

Object Name	Static Structural (C5)
State	Solved
<b>Definition</b>	
Physics Type	Structural
Analysis Type	Static Structural
Solver Target	Mechanical APDL
<b>Options</b>	
Environment Temperature	22. °C
Generate Input Only	No

**TABLE 29**  
Model (B4, C4) > Static Structural (C5) > Analysis Settings

Object Name	Analysis Settings
State	Fully Defined
<b>Step Controls</b>	

Number Of Steps	1.
Current Step Number	1.
Step End Time	1. s
Auto Time Stepping	Program Controlled
<b>Solver Controls</b>	
Solver Type	Program Controlled
Weak Springs	Off
Solver Pivot Checking	Program Controlled
Large Deflection	Off
Inertia Relief	Off
<b>Rotordynamics Controls</b>	
Coriolis Effect	Off
<b>Restart Controls</b>	
Generate Restart Points	Program Controlled
Retain Files After Full Solve	No
Combine Restart Files	Program Controlled
<b>Nonlinear Controls</b>	
Newton-Raphson Option	Program Controlled
Force Convergence	Program Controlled
Moment Convergence	Program Controlled
Displacement Convergence	Program Controlled
Rotation Convergence	Program Controlled
Line Search	Program Controlled
Stabilization	Program Controlled
<b>Advanced</b>	
Inverse Option	No
<b>Output Controls</b>	
Stress	Yes
Surface Stress	No
Back Stress	No
Strain	Yes
Contact Data	Yes
Nonlinear Data	No
Nodal Forces	No
Contact Miscellaneous	No
General Miscellaneous	No
Store Results At	All Time Points
Result File Compression	Program Controlled
<b>Analysis Data Management</b>	
Solver Files Directory	C:\Users\Raksha B\AppData\Local\Temp\WB_DESKTOP-LAGUD7Q_Raksha B_3848_2\unsaved_project_files\dp0\SYS-1\MECH\



Future Analysis	None
Scratch Solver Files Directory	
Save MAPDL db	No
Contact Summary	Program Controlled
Delete Unneeded Files	Yes
Nonlinear Solution	No
Solver Units	Active System
Solver Unit System	mm

**TABLE 30**  
**Model (B4, C4) > Static Structural (C5) > Loads**

Object Name	Fixed Support	Pressure
State	Fully Defined	
<b>Scope</b>		
Scoping Method	Geometry Selection	
Geometry	2 Faces	10 Faces
<b>Definition</b>		
Type	Fixed Support	Pressure
Suppressed	No	
Define By	Components	
Coordinate System	Global Coordinate System	
X Component	0. MPa (ramped)	
Y Component	0. MPa (ramped)	
Z Component	-1. MPa (ramped)	

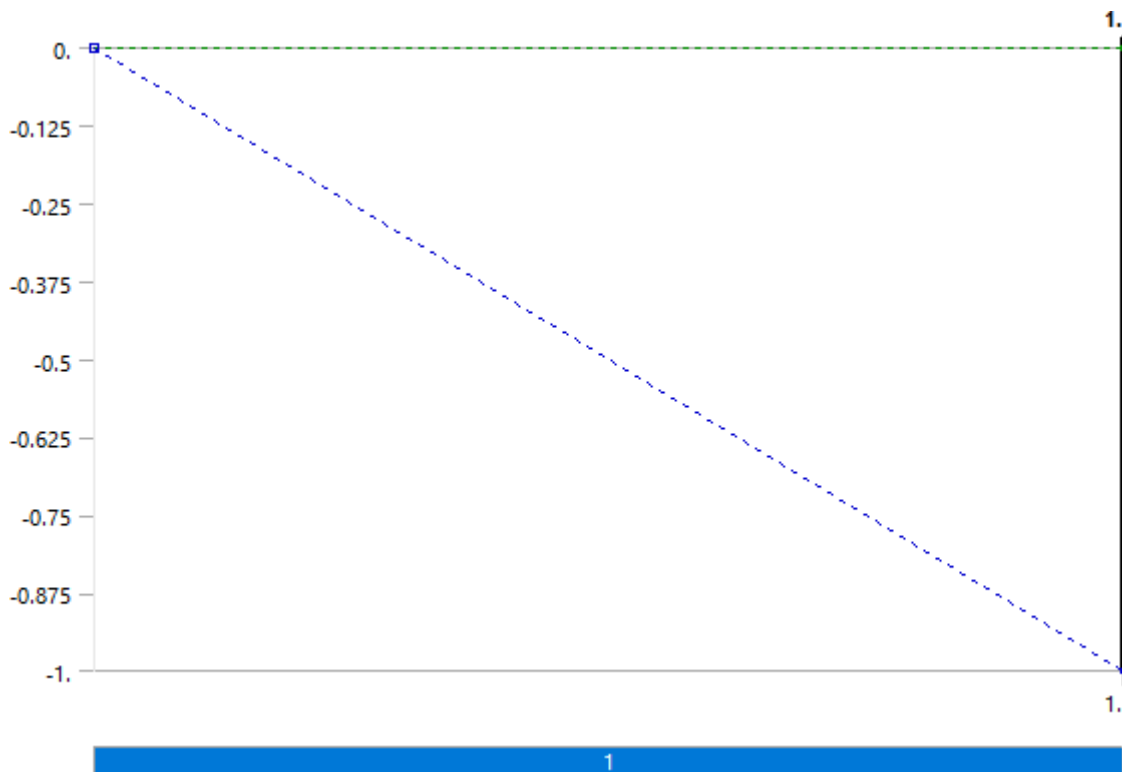

**Figure 6. 14 Model (B4, C4) > Static Structural (C5) > Pressure**

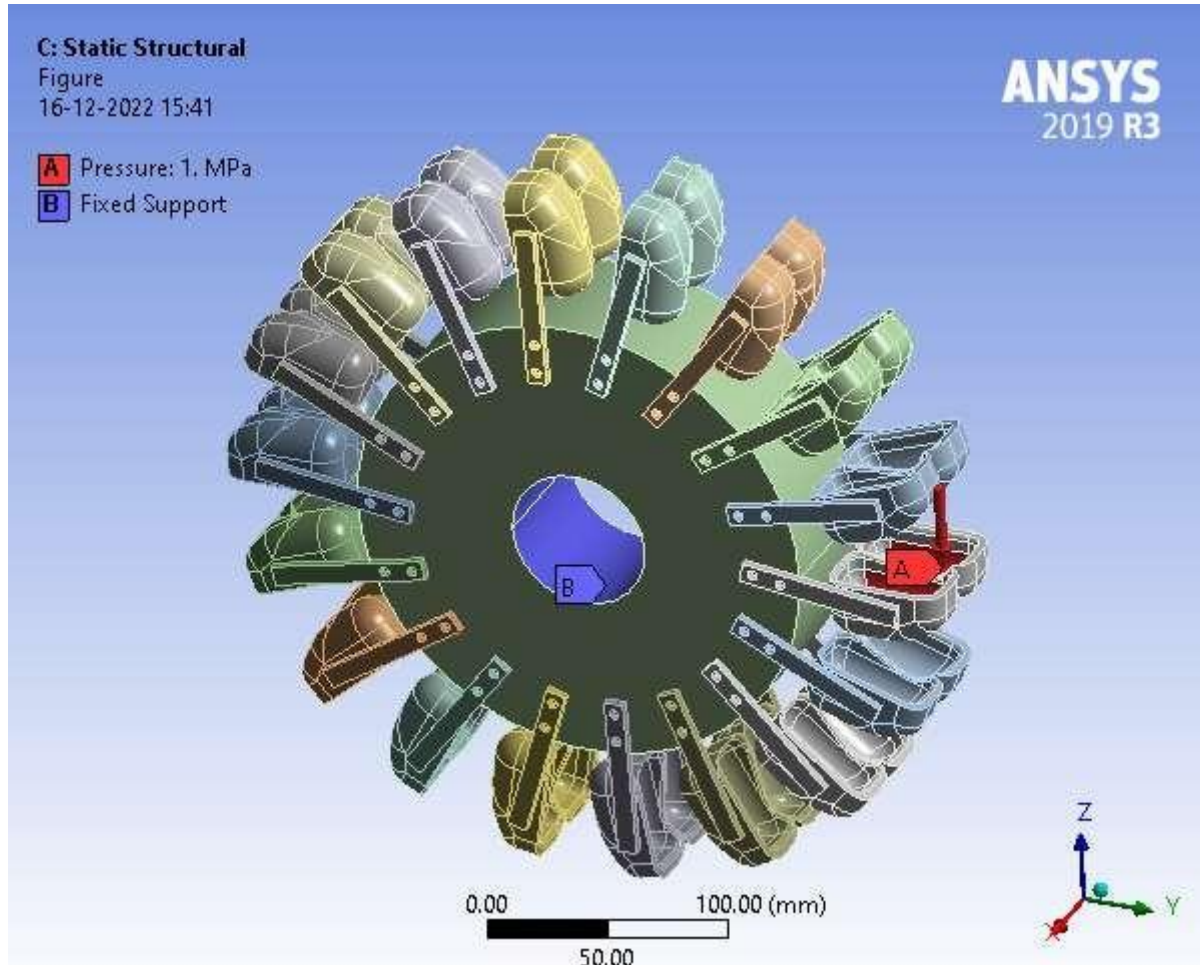

Figure 6. 15 Model (B4, C4) > Static Structural (C5) > Figure

## 6.6 Solution (C6)

**TABLE 31**  
Model (B4, C4) > Static Structural (C5) > Solution

Object Name	<i>Solution (C6)</i>
State	Solved
<b>Adaptive Mesh Refinement</b>	
Max Refinement Loops	1.
Refinement Depth	2.
<b>Information</b>	
Status	Done
MAPDL Elapsed Time	23. s
MAPDL Memory Used	1.2695 GB
MAPDL Result File Size	31.375 MB
<b>Post Processing</b>	
Beam Section Results	No
On Demand Stress/Strain	No

**TABLE 32**  
**Model (B4, C4) > Static Structural (C5) > Solution (C6) > Solution Information**

Object Name	<i>Solution Information</i>
State	Solved
<b>Solution Information</b>	
Solution Output	Solver Output
Newton-Raphson Residuals	0
Identify Element Violations	0
Update Interval	2.5 s
Display Points	All
<b>FE Connection Visibility</b>	
Activate Visibility	Yes
Display	All FE Connectors
Draw Connections Attached To	All Nodes
Line Color	Connection Type
Visible on Results	No
Line Thickness	Single
Display Type	Lines

**TABLE 33**  
**Model (B4, C4) > Static Structural (C5) > Solution (C6) > Results**

Object Name	<i>Total Deformation</i>	<i>Equivalent Stress</i>	<i>Equivalent Elastic Strain</i>
State	Solved		
<b>Scope</b>			
Scoping Method	Geometry Selection		
Geometry	All Bodies		
<b>Definition</b>			
Type	Total Deformation	Equivalent (von-Mises) Stress	Equivalent Elastic Strain
By	Time		
Display Time	Last		
Calculate Time History	Yes		
Identifier			
Suppressed	No		
<b>Results</b>			
Minimum	0. mm	1.3184e-006 MPa	1.693e-011 mm/mm
Maximum	1.1817 mm	1016.4 MPa	5.1535e-003 mm/mm
Average	3.0159e-002 mm	2.1632 MPa	1.4595e-005 mm/mm
Minimum Occurs On	pelton-FreeParts Body.2		
Maximum Occurs On	pelton-FreeParts PartBody.1		
<b>Information</b>			
Time	1. s		
Load Step	1		
Substep	1		
Iteration Number	1		
<b>Integration Point Results</b>			
Display Option	Averaged		
Average Across Bodies	No		

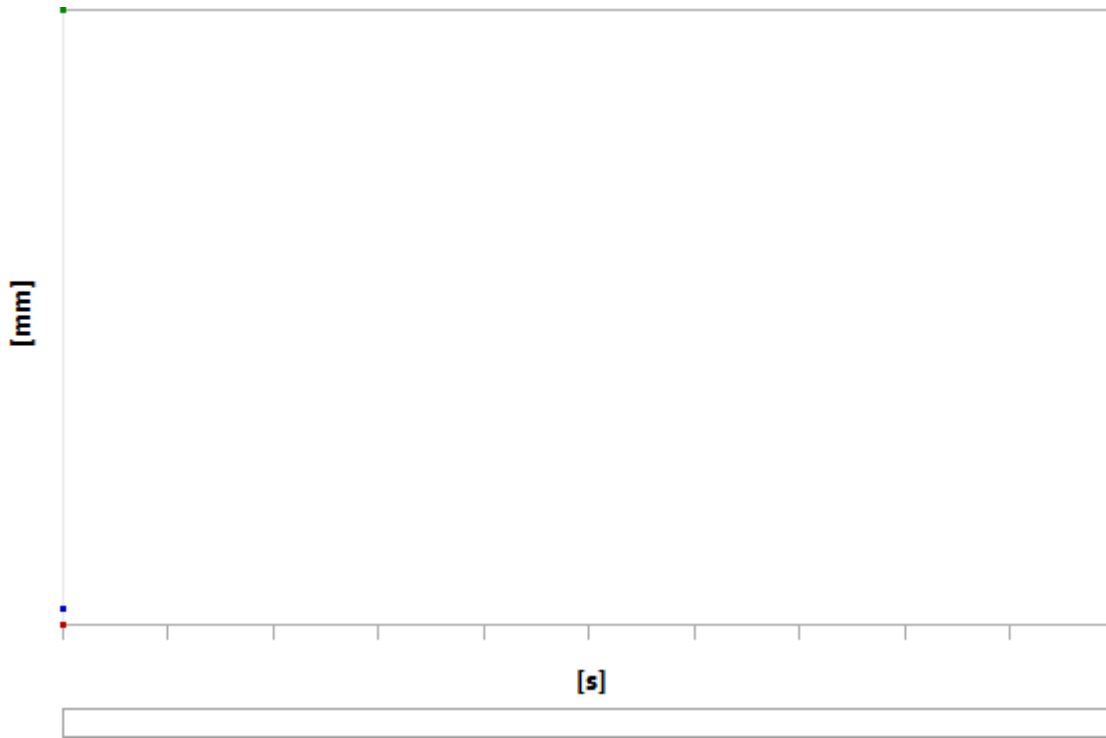

Figure 6. 16 Model (B4, C4) > Static Structural (C5) > Solution (C6) > Total Deformation

TABLE 34  
Model (B4, C4) > Static Structural (C5) > Solution (C6) > Total Deformation

Time [s]	Minimum [mm]	Maximum [mm]	Average [mm]
1.	0.	1.1817	3.0159e-002

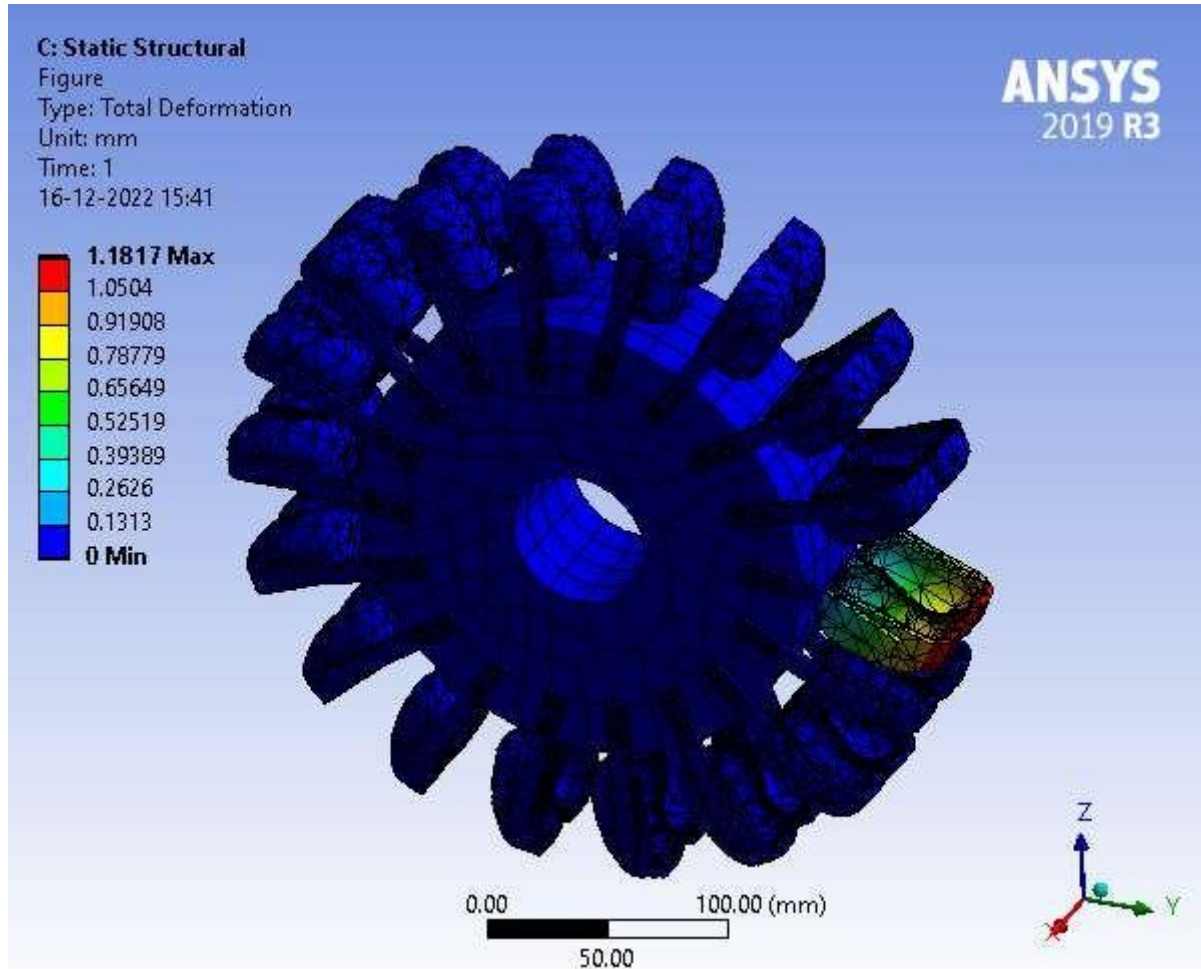

Figure 6. 17 Model (B4, C4) > Static Structural (C5) > Solution (C6) > Total Deformation > Figure

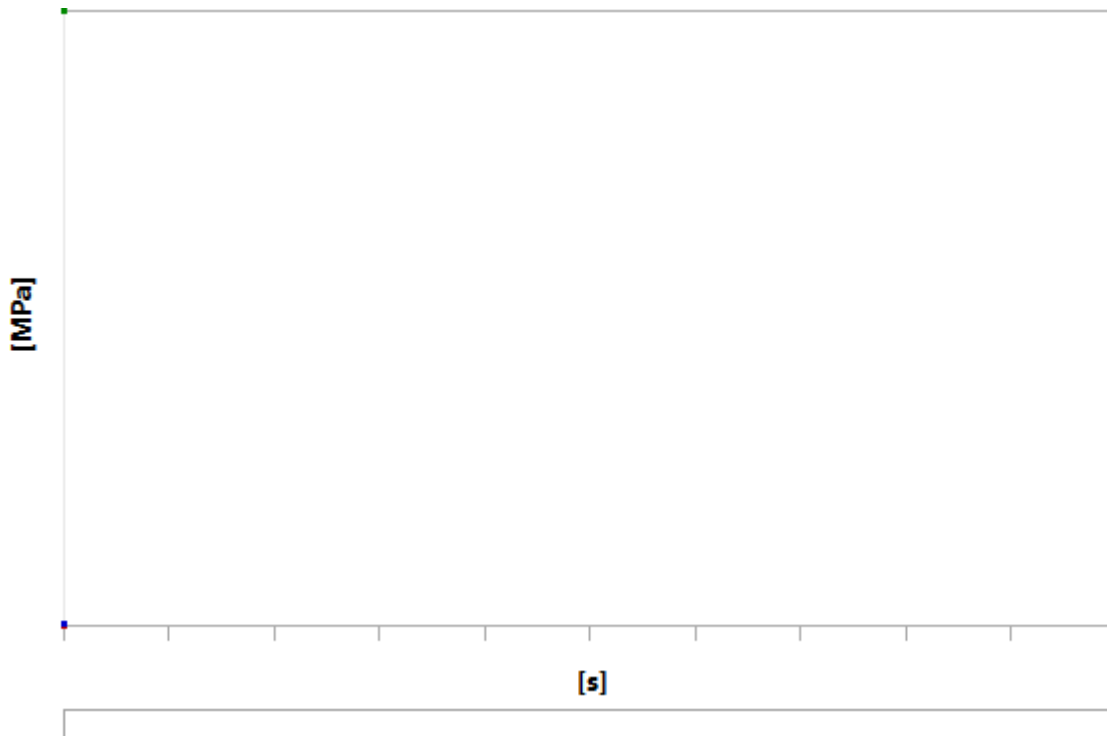

Figure 6. 18 Model (B4, C4) > Static Structural (C5) > Solution (C6) > Equivalent Stress

**TABLE 35**  
**Model (B4, C4) > Static Structural (C5) > Solution (C6) > Equivalent Stress**

Time [s]	Minimum [MPa]	Maximum [MPa]	Average [MPa]
1.	1.3184e-006	1016.4	2.1632

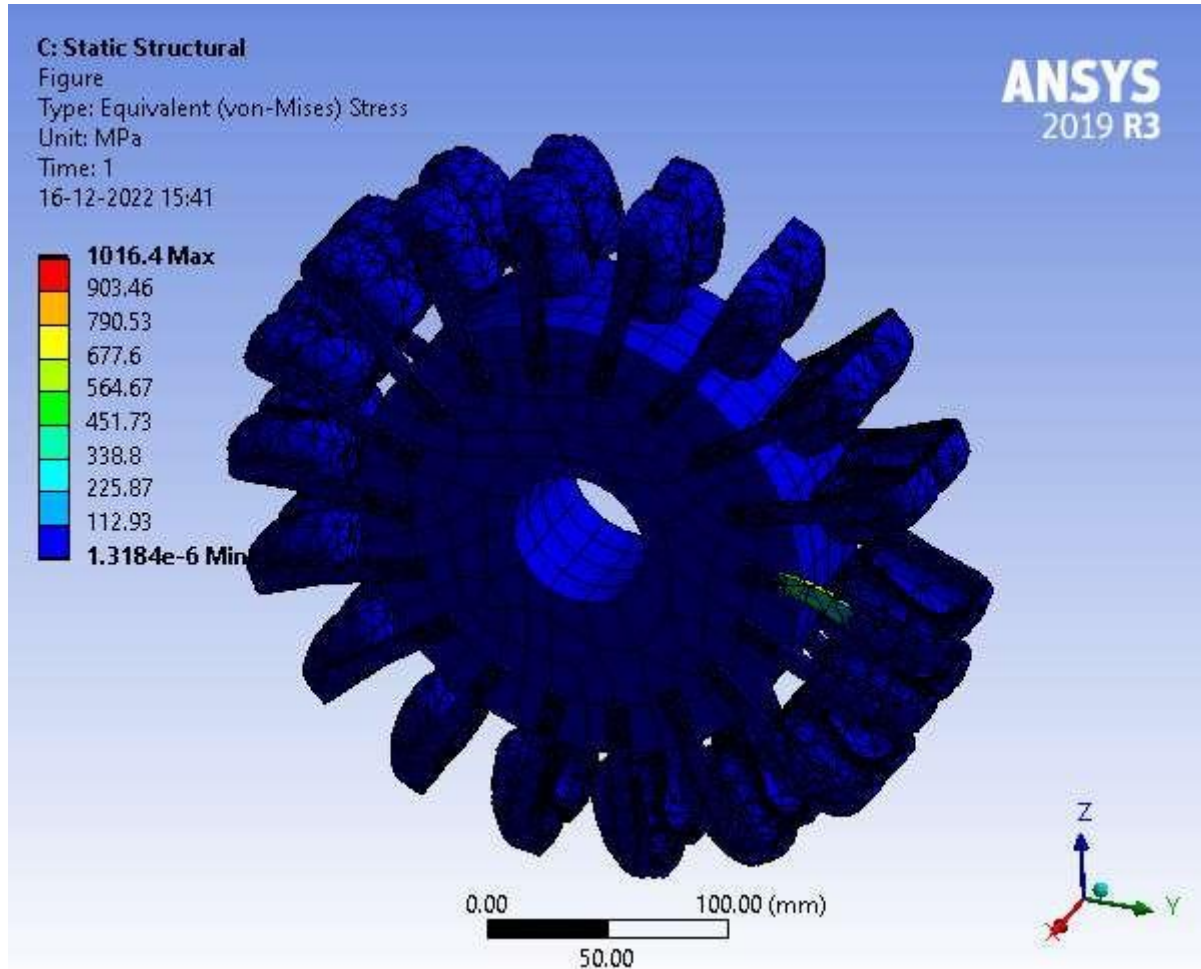

Figure 6. 19 Model (B4, C4) > Static Structural (C5) > Solution (C6) > Equivalent Stress > Figure

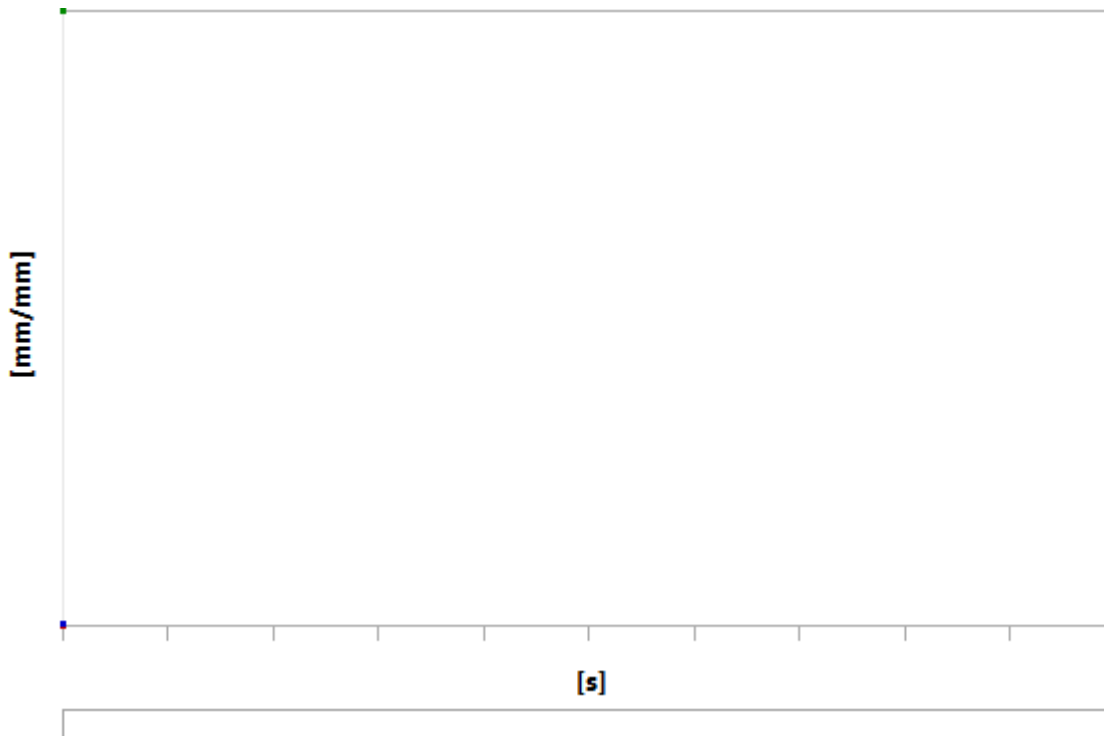

Figure 6. 20 Model (B4, C4) > Static Structural (C5) > Solution (C6) > Equivalent Elastic Strain

**TABLE 36**  
**Model (B4, C4) > Static Structural (C5) > Solution (C6) > Equivalent Elastic Strain**

Time [s]	Minimum [mm/mm]	Maximum [mm/mm]	Average [mm/mm]
1.	1.693e-011	5.1535e-003	1.4595e-005



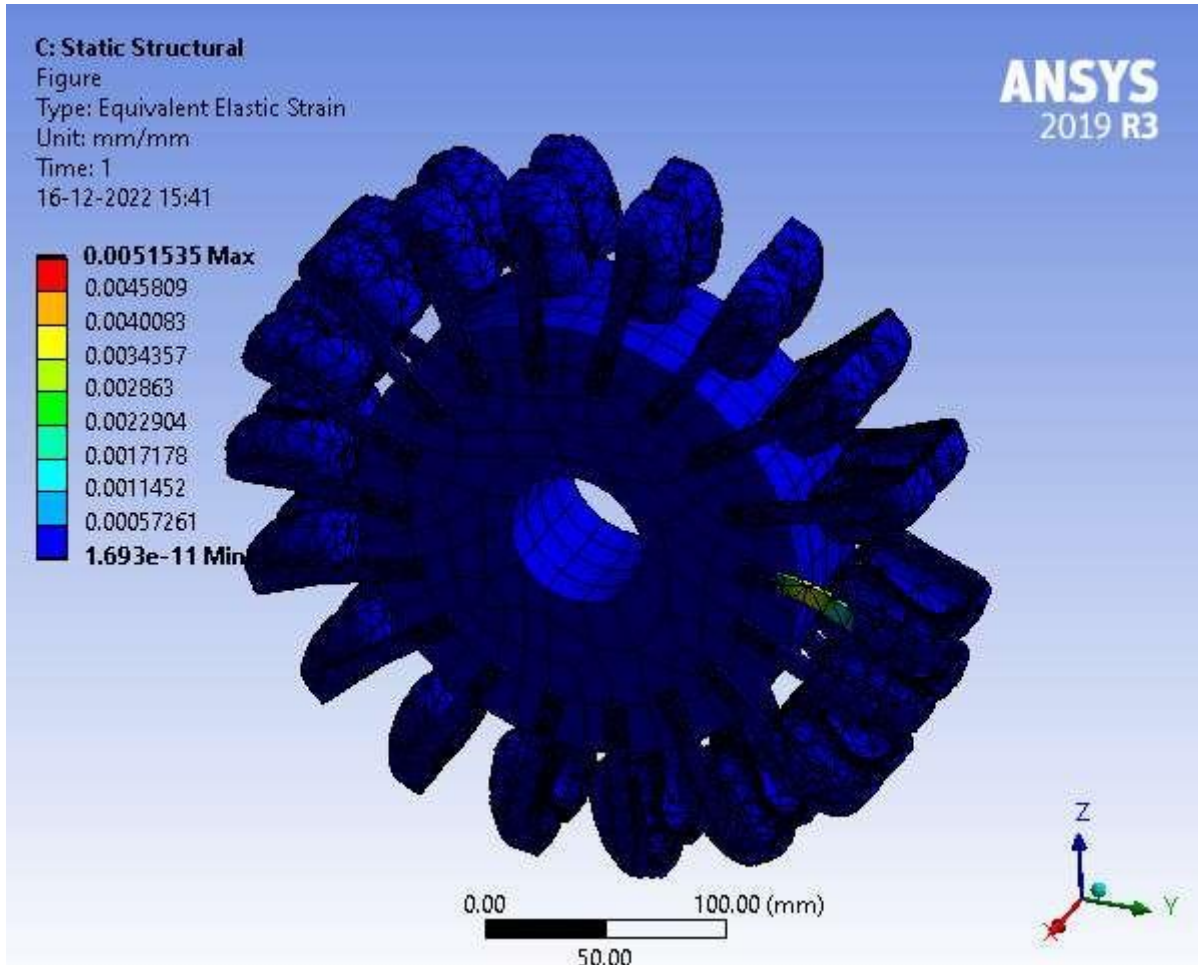

Figure 6. 21 Model (B4, C4) > Static Structural (C5) > Solution (C6) > Equivalent Elastic Strain > Figure

## 6.7 Structural Steel

**TABLE 37**  
Structural Steel > Constants

Density	7.85e-006 kg mm <sup>-3</sup>
Coefficient of Thermal Expansion	1.2e-005 C <sup>-1</sup>
Specific Heat	4.34e+005 mJ kg <sup>-1</sup> C <sup>-1</sup>
Thermal Conductivity	6.05e-002 W mm <sup>-1</sup> C <sup>-1</sup>
Resistivity	1.7e-004 ohm mm

**TABLE 38**  
Structural Steel > Color

Red	Green	Blue
132	139	179

**TABLE 39**  
Structural Steel > Compressive Ultimate Strength

Compressive Ultimate Strength MPa

0

**TABLE 40**  
**Structural Steel > Compressive Yield Strength**

Compressive Yield Strength MPa
250

**TABLE 41**  
**Structural Steel > Tensile Yield Strength**

Tensile Yield Strength MPa
250

**TABLE 42**  
**Structural Steel > Tensile Ultimate Strength**

Tensile Ultimate Strength MPa
460

**TABLE 43**  
**Structural Steel > Isotropic Secant Coefficient of Thermal Expansion**

Zero-Thermal-Strain Reference Temperature C
22

**TABLE 44**  
**Structural Steel > S-N Curve**

Alternating Stress MPa	Cycles	Mean Stress MPa
3999	10	0
2827	20	0
1896	50	0
1413	100	0
1069	200	0
441	2000	0
262	10000	0
214	20000	0
138	1.e+005	0
114	2.e+005	0
86.2	1.e+006	0

**TABLE 45**  
**Structural Steel > Strain-Life Parameters**

Strength Coefficient MPa	Strength Exponent	Ductility Coefficient	Ductility Exponent	Cyclic Strength Coefficient MPa	Cyclic Strain Hardening Exponent
920	-0.106	0.213	-0.47	1000	0.2

**TABLE 46**  
**Structural Steel > Isotropic Elasticity**

Young's Modulus MPa	Poisson's Ratio	Bulk Modulus MPa	Shear Modulus MPa	Temperature C
2.e+005	0.3	1.6667e+005	76923	

**TABLE 47**  
**Structural Steel > Isotropic Relative Permeability**

Relative Permeability
10000

### Total Deformaton Test

Sl.no	Frequency	Minimum Deformation	Maximum Deformation
1	472.56Hz	0	96.77
2	474.25Hz	0	96.805
3	494.62Hz	0	83.785
4	496.63Hz	0	75.219
5	497.32Hz	0	56.634

### Static structural

Sl.no	Time in Secs	Min Deformation	Max deformation	Avg Deformation
1	1	0	1.1817	3.0159e-002

Equivalent Stress:				
Sl.no	Time	Minimum Stress(Mpa)	Maximum stress(Mpa)	Average
1	1	1.3184e-006	1016.4	2.1632

Equivalent Strain:				
Sl.no	Time	Minimum Stress	Maximum Strain	Average
1	1	1.693e-0.11	5.5135e-003	1.4395e-005

## 7. CONCLUSIONS

From the literature review it is seen that, very less work has been done in the field of the dynamic behavior of pelton wheel turbine and their effects in design and operation. Forced vibration is that mode of vibrations in which the system vibrates. Having the mode of vibrations, this may cause a serious damage of the machine.

By the analysis of numerical and experimental we observed as frequency coincides in deformation test so the excitation of resonance and strength is under standard limit with natural frequency. This resonance forms less chances of failure, which mean no need of redesign and structural changes.

## REFERENCES

- [1] Aman Rajak, et al., dynamic analysis of pelton turbine and assembly, proceedings of IOE graduate conference, Nepal, 2014 pp. 103-109.
- [2] Lixiang zhang et al., analysis of dynamic characteristics of the main shaft system in a hydro- turbine based on ANSYS, procedia engineering 31 (2012) pp. 654 – 658
- [3] Uzma nawaz<sup>1</sup>, muhammad naeem arabab, gul rukh, international journal of electrical and computer sciences, 14 (06), 2014, pp. 1-6
- [4] Chong-won lee, saving campbell diagram for dynamic analysis of complex rotor systems, icsv20, bangkok, thailand, july 2013, pp. 1-14.
- [5] Jiaqi liang, pumped storage hydro-plant models for system transient and long-term dynamic studies, institute of electrical and electronics engineers, 2007 pp 1-8.
- [6] Prakash k. Dhakan and abdul basheer pombra chalil, design and construction of main casing for four jet vertical pelton turbine, engineering mechanics, vol. 20(2) 2013, pp. 77–88
- [7] Ze li and lixiang zhang, research on numerical method of flow-induced vibration on spiral casing structure of large-scale hydropower station, international conference on advances in computational modeling and simulation, China, 2012, pp 689-695
- [8] J.C. Chavez et al., Failure analysis of a Pelton impeller, Elsevier Ltd. Vol. 48, (2015), pp. 297–307
- [9] Amod panthee, et al., CFD analysis of pelton runner, international journal of scientific and research publications, vol. 4(8), 2014 ISSN 2250-3153 pp 1-8.
- [10] Bilal Abdullah Nasir, design of high efficiency pelton turbine for micro hydro power plant, international journal of electrical engineering and technology, vol. 4(1), (2013), pp. 171-183
- [11] D jost, et al., numerical prediction of pelton turbine efficiency, iop conf. Series: earth and environmental science, in UK, 12 (2010) pp 1-8.