

EMBEDDED BASED BATTERY MANAGEMENT SYSTEM FOR ELECTRIC VEHICLES

E.RAMYA¹, A.MADHAN², S.HARISH³, C.DHACHINAMOORTHY⁴

¹Assistant Professor, EIE Department, Bannari Amman Institute of Technology, Tamilnadu, India

²BE Student, EIE Department, Bannari Amman Institute of Technology, Tamilnadu, India

³BE Student, EIE Department, Bannari Amman Institute of Technology, Tamilnadu, India

⁴BE Student, EIE Department, Bannari Amman Institute of Technology, Tamilnadu, India

-----***-----
Abstract -To make a pollution free environment the modern civilization is trying to utilize the electricity from the renewable resources for driving the automobiles rather than non-renewable resources such as petrol or diesel. While utilizing the electricity, it storage plays a major role. The charging and the discharging parameters of the electric vehicles battery must be studied in detail and must be kept in a certain limit in order to attain a good efficiency. So the parameters such as the voltage, State of Charge (SOC) of the battery are obtained and monitored. Further the temperature plays a major role in the performance of the battery; the temperature around the battery must be in a certain range in order to get a good battery performance. Hence this parameter is also monitored. Overcharging of the battery leads to damage and the emission of the hydrogen gas, this is detected by using a gas sensor. These parameters are sent to the IOT platform such as Thingspeak using the ESP8266 module in order monitor the parameters of the electric battery remotely. Based on the data from the electric battery its efficiency is determined.

Key Words: Non-renewable resources, State of Charge, IOT, temperature, hydrogen gas, ESP8266, electric vehicles.

1. INTRODUCTION

1.1 INTRODUCTION TO ELECTRIC BATTERIES

In many devices batteries are used as the source of power. By relying on the fact that the DC can be stored, the batteries play a vital role in it and because of its compact size battery can be easily portable. The use of batteries started in the year of 1859 when the French Physicist Gaston Plante invented the lead acid battery. In the late 19th century and in the early 20th century the use of the electric batteries to power the vehicle became popular. As the exploration of the petroleum began, the combustion of these fossil fuels made to run the vehicles over a great range, thus the use of the electrical vehicles shrunk. Moreover, the fossil fuel created enormous

pollution due to the carbon emissions. And also they are non-renewable and are depleting. And thus at the start of 21st century people are looking for alternate energy sources to power the vehicles. Now the electric batteries come into the picture, which can create a pollution free environment.

1.2 NEED FOR BATTERY MANAGEMENT SYSTEM

It is often necessary to determine the state of charge and temperature of a battery, so that the device which is operated works without any discontinuation and check whether it works efficient. Since the battery property varies over a certain period it is necessary to monitor the battery regularly. Several researchers have proposed various mathematical models to find the SOC and temperature of the battery. But in practical it is not possible to determine the SOC of the battery accurately. Nowadays, the electrical vehicles and hybrid electric vehicles are popular and use batteries as their power source.

But the charge of the battery in the electric vehicle will discharge when it is used or it may get self-discharge due to certain problem in it. So it is crucial to know about the state of charge and temperature of the battery used in these vehicles. The battery may be affected by self-discharge, temperature effects, aging, etc. Since the battery output is affected by enormous factors such as temperature, humidity and loading effects, there is no accurate method for determining the state of charge and temperature of the batteries either it is rechargeable or not.

This varying property of the battery makes the estimation of SOC and temperature of a battery of it difficult. However it is not possible to determine the state of battery and temperature of a battery just by looking it physically. Moreover it is difficult to analyze a battery which is under operation or connected to some external source.

1.3 STATE OF CHARGE (SOC)

State of charge is defined as the current capacity of the battery over any period of time reference to the maximum rated capacity when it was manufactured. It is usually expressed in percentage. It usually provides the information about certain parameters such as maximum voltage of the battery, present battery voltage, discharge rate, maximum rechargeable level, etc. Hence it is necessary to know about the state of charge.

1.4 TEMPERATURE OF THE BATTERY

A lead acid battery can perform efficiently in the temperature range of 20°C and 30°C. The performance of the battery can be affected seriously onset of extreme temperature. The chemicals in the battery cannot react fast in cold weather as compared to warm temperature, because batteries are the functions of chemical reactions. The chemical discharge becomes slower in the cold temperature and extends the battery life. A battery at cold temperature will work in a good condition but still it does not have the same power as the battery which is kept in warmer conditions.

1.5 OBJECTIVES

1. To measure the battery in terms of their voltage, current, state of charge and internal temperature.
2. To model of electric vehicle is simulated to investigate the energy flow.
3. The observed measurements of the battery are sent to the user regularly.

2. METHODOLOGY

2.1 BLOCK DIAGRAM

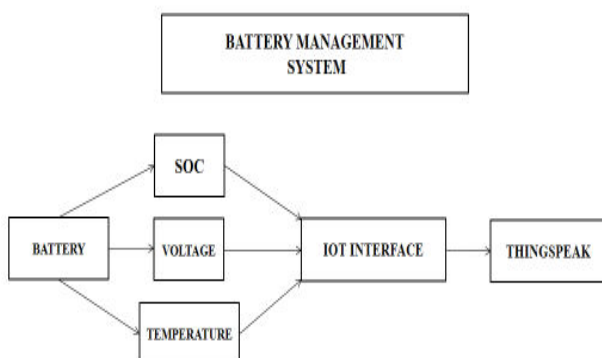

Fig -1: Block diagram for battery management system

In the battery management system the voltage, state of charge (SOC) and temperature of a lead acid battery is measured. The measured values are sending to the IOT platform Thingspeak. This IOT connection is done by using the ESP8266 module. The program to this module

is fed by using the arduino software. To measure the voltage a voltage division circuit is used, 12V from the lead acid battery is divided as 8.7V and 3.3V. This 3.3V is fed to the ESP8266 module. The SOC is found out by converting the voltage to percentage, since the SOC is always mentioned in percentage.

The temperature measured is the external temperature of the battery, because the internal temperature is very tedious process. Temperature is measured by using the DHT sensor; it consists of a thermistor in it. Finally all these parameters are monitored by using Thingspeak, the real time values get updated for every 15 seconds.

2.2 FLOW CHART

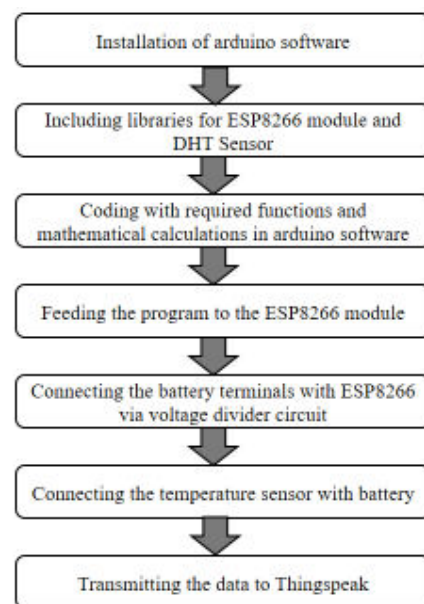

Fig -2: Working flow for the BMS

As the first work the arduino software is installed. The libraries for ESP8266 and DHT sensor are downloaded.

The coding is done in arduino software as such to calculate the SOC in percentage from the voltage data which is got by using mathematical calculations. The coded program is fed to ESP8266 module. The circuit connections are made and the values of temperature and voltage are given to ESP8266 module. The temperature is measured by using DHT sensor which has a thermistor in it. These data are transmitted to the IOT platform like Thingspeak and monitored.

3. HARDWARE REQUIREMENTS

3.1 LEAD ACID BATTERY

The lead acid battery was invented a French physicist Gaston Plante in the year of 1859. Lead and lead oxide are the anode and cathode respectively. During the charging process the cathode becomes anode and the

cathode becomes anode. The electrolyte used here is sulfuric acid. By relying on the fact that the charge in the battery can be restored; these types of batteries are used in wide range of applications.

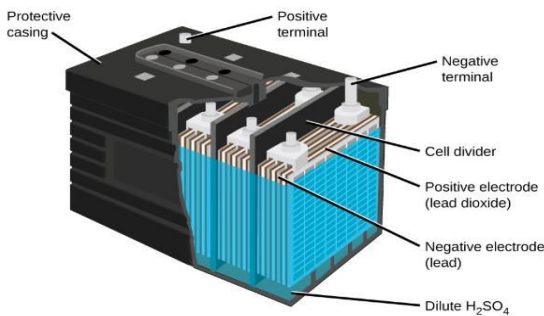

Fig -3: Lead acid battery

Thus the lead acid batteries are used as the source of power in electric vehicles. The batteries may get self-discharged due to ageing and various other reasons. In the project the battery's efficiency is evaluated by depending on the various factors such as voltage, SOC and temperature of the battery. If the speed of the vehicles must be high the batteries are connected in series and if the mileage needed to be maintained then the batteries can be connected in parallel. In the sealed lead acid batteries there is no leakage and evaporation of sulfuric acid and it is be easily portable.

3.2 ESP8266 MODULE

ESP8266 module provides an IOT platform and is also called as NODEMCU. ESP8266 is WiFi microchip with a TCP/IP protocol with microcontroller capability and it is cheap. It can transmit the data to the cloud once it is connected by internet. ESP8266 is used to monitor the parameters such as voltage, SOC and the temperature of the battery remotely.

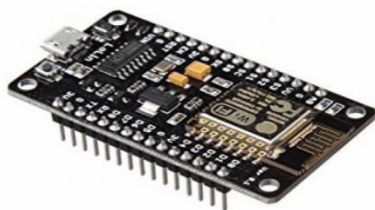

Fig -4: ESP8266 module

In the project the parameters of the battery are transmitted to the Thingspeak via ESP8266 module. Using the arduino software and downloading the required libraries for ESP8266 the required program can be coded and fed to the ESP8266 module.

3.3 DHT SENSOR

The temperature at which the lead acid battery is kept plays a vital role in the performance of the battery, because it may affect the chemical reaction that takes place inside the lead acid battery. The battery performs better in the temperature range of 20°C and 30°C.

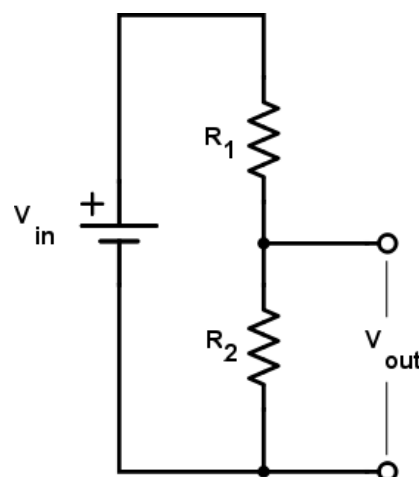

Fig -5: DHT sensor

Hence it is necessary to measure the temperature of the battery. DHT sensor comes in handy while doing this operation; it is a cheap and best sensor. It consists of thermistor for measuring the temperature. It measures the corresponding temperature and sends it to the ESP8266 module.

3.4 VOLTAGE DIVISION CIRCUIT

The lead acid battery used is of 12V. This 12V can't be fed directly to the ESP8266 module, since a voltage above 3.3V might damage the module. For this process the voltage division technique is employed. The circuit consists of two resistors connected in series. The positive terminal of the battery is given to one end of the resistor, while the other end of the second resistor is connected to ground. The connection of voltage division



technique is shown in figure3.2.

Fig -6: Voltage divider circuit

The voltage drop across the resistor 2 is directly proportional to the input voltage. This voltage drop is given to the ESP8266 module. Hence by knowing this value, the input voltage can be determined.

4. ALGORITHM

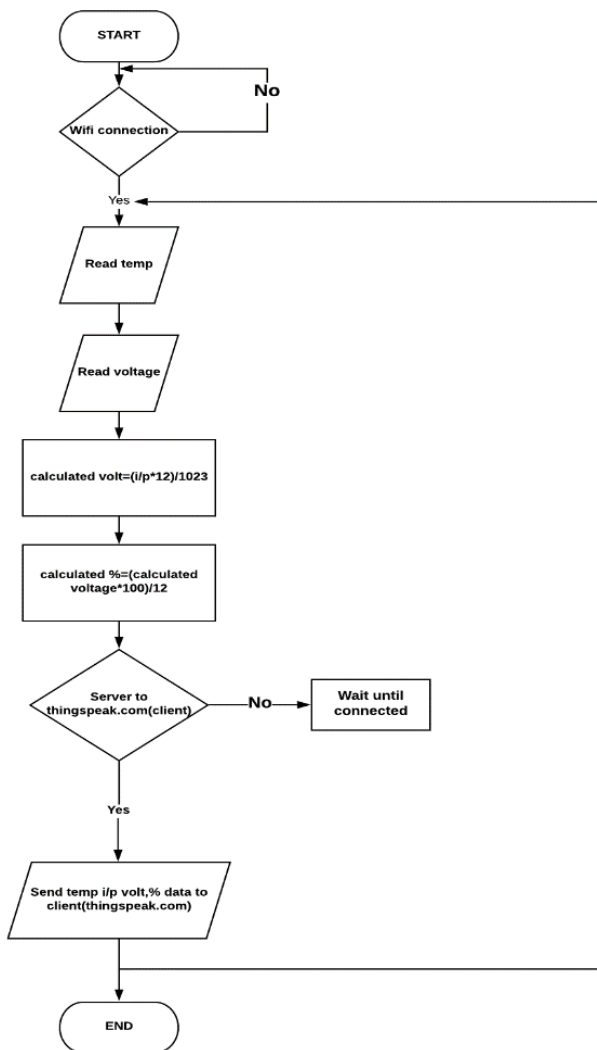

Fig -7: Algorithm of the project

5. SOFTWARE IMPLEMENTATION

5.1 THINGSPEAK

Thingspeak is an IOT platform that helps us to acquire the data from the sensors and save it in the cloud, and then displays the data. Thingspeak is very much useful in the development of the IOT applications.

The data can be made private or public and helps us to act accordingly based on the retrieved data. The data in Thingspeak get updated 15 seconds once. In this project the parameters of the battery are send to Thingspeak via ESP8266 module and monitored remotely.

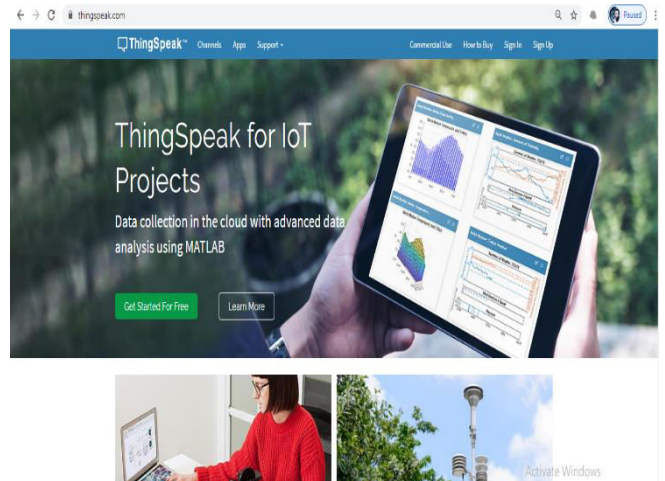

Fig -8: Thingspeak icon

6. RESULT AND DISCUSSION

This project is quite accurate method for calculating SOC and temperature. This method is also known as the voltage method, in which the SOC is calculated indirectly by voltage value rather than calculating from the value of current. Even though the battery output is affected by environment factors, the proposed method provides the real value of battery at any cause and provides output of battery temperature.

The SOC of electric vehicles battery and its temperature is displayed graphically in Thingspeak where the data is monitored remotely in the IOT platform. The analog voltage from the battery which is converted digitally will be of range 0 to 1023 in the transmission of data, this value is converted to corresponding voltage value for further calculations in the programming.

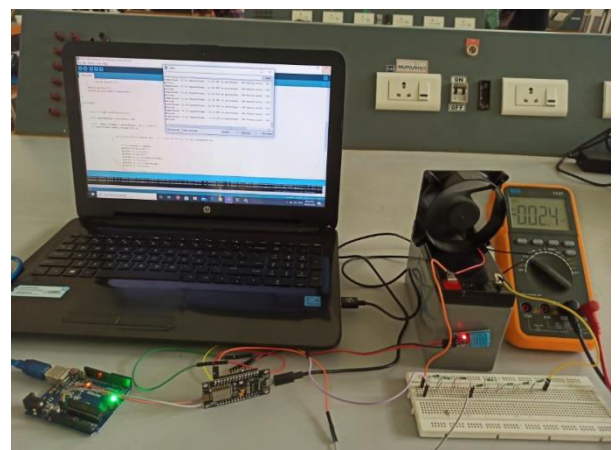

Fig -9: Output of the project

- [V] Y Mastanamma et al, “Electric Vehicle Mathematical Modelling and Simulation using MATLSB-Simulink”, IOSR Journal of Electrical and Electronics Engineering (2017).

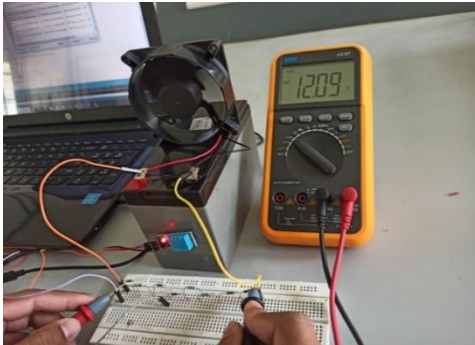

Fig -10: Voltage across resistors

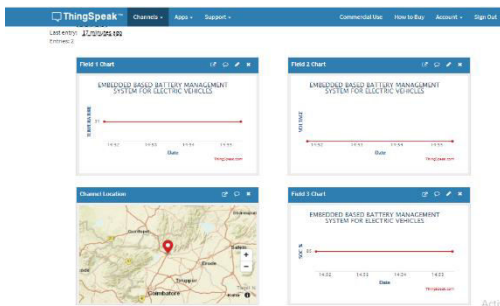

Fig -11: Data's to Thingspeak

7. FUTURE SCOPE

The fully electrically operated vehicles will come in future because of depleting fossil fuels and will create definitely create an impact in everyone's life. At this time the battery management system will be major phenomena that the every electric vehicle manufacturing company will be looking for. There are various methods for the determination of SOC, these methods may be used of the efficient finding of SOC. The further development of the project will be the creation of an application by incorporating IOT platform in it, to access and monitor the data at ease.

REFERENCES

- [I] Mohd Helmy Abd Wahab et al, “IoT-Based Battery Monitoring System for Electric Vehicle”, International Journal of Engineering & Technology (2018).
- [II] M Ramesh Kumar et al, “Battery Monitoring System using IoT”, International Journal of Scientific Development and Research (2018).
- [III] N Harish et al, “IOT Based Battery Management System”, International Journal of Applied Engineering Research (2018).
- [IV] Vaibhav Verma et al , “LabVIEW-based Battery Monitoring System with Effects of Temperature on Lead-Acid Battery”, International Journal of Enhanced Research in Science Technology & Engineering (2013).