

# IoT Based Solar Power Monitoring System

Prof. Rawnak Bansod<sup>1</sup>, Sanjana Tandekar<sup>2</sup>, Pooja Gajbe<sup>3</sup>, Rhunal Gaurkar<sup>4</sup>, Amisha

Nandurkar<sup>5</sup>, Sohini Ramteke<sup>6</sup>, Pragati More<sup>7</sup>, Shafique Alam<sup>8</sup>

<sup>1</sup>Project Guide, Department of Electricals, NIT Polytechnic, Nagpur, India.

<sup>2,3,4,5,6,7,8</sup>Students, Department of Electricals, NIT Polytechnic, Nagpur, India.

## Abstract-

This paper proposes a solution and method to monitor the dust accumulated on the solar panels to get the maximum power from for effective utilization. Always the output power of the solar panel depends on the radiation reached to the solar cell. The system also displays the malfunctioned solar panels lists and whether the electrical appliance is working directly on the solar panels or the loads is on the battery. All the panels are connected, and sensors are directly connected to the central controller which monitors the panels and loads. By incorporating the IoT technology the data received from the panels and appliance are sending to the cloud from through internet for the future use as well the remote user can monitor the parameters of the connected devices. The user can view the current, previous, and average parameters such as voltage. The controller is programmed with predefined conditions with user alerts when it falls below the specified conditions. Node MCU is used as a controller.

**Keywords:** Internet of Things (IoT), NODE MCU, GSMA, PV, Solar panel, LCD, Webserver.

## 1. Introduction

Internet of things (IoT) is playing a major and crucial role in the daily life of humans by enabling the connectivity of many and most of the physical devices through internet to exchange the data for monitoring and controlling the devices from a remote location, where the devices are becomes intelligent [1]. This technology can connect a wide range and varieties of things such as animals, humans, smart transport, smart grids, virtual power grids, smart cities, vehicles, heart monitoring systems, environmental sensing, shopping systems, automated homes, energy management, assistance for disabled and elderly individuals, cochlear implants, tracking of things, equipment manufacturing, agriculture, emergency monitoring systems, electronics tool collection systems, vehicle control etc. according to the survey there is a increase of 31% i.e 8.4 billion internet connected devices from 2016-2017. The connected device may increase to 30 billion by 2020 and which makes the business market around 7.1 trillion dollars by 2020 [2]. By using the IoT we can enable the machine to machine communication M2M or device to device communication without human intervention.

In the modern life electricity became the important and essential part of the life. For any work now, a day we require electricity like lighting, heating, refrigeration, cooling, transportation systems what not all the home appliance works on electricity. In day to day life the consumption of electricity is increased but not

decreased. To compete with the requirement of the public more and more electricity is to be generated and give to the end users. As the population increases the consumption also increases.

The power is generated in three methods generators, electro chemistry, photovoltaic effect.

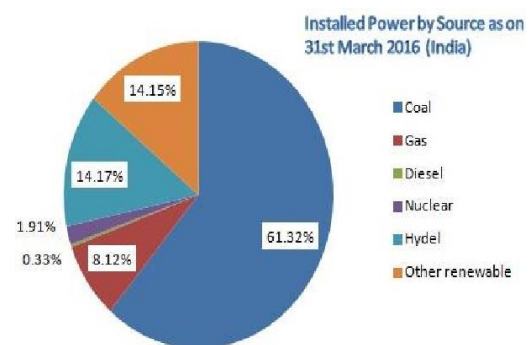

Fig. 1: The percentage of power sources installed

The electric generator is the most used form to generate the electricity which based on faraday's law of electromagnetic induction by transforming the mechanical energy into electrical energy. Storing the electricity in a battery is called electro chemistry which transforms the chemical energy to electrical energy. The other source to electricity is renewable energy which transforms the light energy into electrical energy which is known as photovoltaic effect we call this as solar energy. In this the electricity is generated from free, abundant sunlight.

The mechanically generated power is cheaper than compared with solar power to produce in large quantities due to of photovoltaic solar panels. In remote locations where there is no commercial power solar energy becomes the source for the home and other things. In the recent era the solar panels are deployed dramatically, and subsidies are given. Due the environmental conditions like global warming the all countries reduced production of electricity by burning the fossil fuels. A Typical solar module consists of 6x10 photovoltaic solar cells which can generate the power for residential applications. If requires the more power than more number of panels to installed. The panel produces DC output power in range of 100 to 365 Watts.



**Fig. 2:** Solar Panels

To produce huge electricity for the commercial and business purpose no of panels are placed in a array which are called as solar plants. Always the output power of the solar panel depends on the radiation reached to the solar cell that convert into electric energy. if the dust is more on the panel then the less electricity is produced where the effectiveness of the solar panel decreases. To increase the efficiency of the solar panels some improvement must be done. In paper we propose a system that monitors the dust formed on the panels. Systems consists of a controller incorporated with Node MCU, LDR sensor. The controllers check the predefined conditions that are programmed and detects whether dust is from through the output voltage and give the alerts to the users or the maintenance in charge. It also uses the things speak cloud to show the received data from sensor and GUI to monitor [9].

## 2. Literature of the Existing Method

Many researchers had made many studies in this major problem and proved that 50% of the PV solar panels performance reduces by the dust accumulation on the cleaned panels.



**Fig. 3:** Solar module covered by heavy layer due to dust accumulation before cleaning

The studies made on the effects that causes to the solar panel due dirt the by well-known organization in the world google of 1.6 MW solar plant in there California headquarters [3]. 4.7% average loss is recorded in the pioneer's investigations by impact of dust in the solar systems that is made by the authors Hottel e.l. [4]. The

authors Salim et al made an investigation on dust accumulation and stated that there is a 32% reduction of solar power in a span of eight months in a solar village near Riyadh [5]. An experiment is conducted by the authors Dirk Goosen et. Al in [6] on the deposition of the dust particles which had affected the performance of the PV cells and investigated the airborne concentration and wind velocity effect caused by accumulation of dust. Author Garg of Roorkee made an experiment and discovered that panel would reduce 8% average transmittance by the accumulation of dirt on 45-degree tilted glass plate after a 10-day period [7].

Due to accumulation of dust on the panels it is observed that useful energy is reduced by 30%. The common methods used to clean the dust is by spraying water on the panels with cleaning agent. Vibrating the panels with motors as the cell phone vibrates so that the dust goes off from the panels. The dust jumps off from the panels by creating a positive charge. By using a brush manual, we must clean the PV panels.

Solar panel monitoring is important. It is vital that solar panels are monitored regularly in one way or another. You need to make sure they are operating correctly, and the system is generating as much as predicted. If you have solar panels installed, you should at the very least check the generation meter once a week and take a note of the reading [8]. And should go to the place of the panels arranged and note the readings every time. It is a manual checking procedure, always should go to the place of solar panel system arrangement to note down the readings. So, it is not possible to take readings all the time, whenever required should go to the place of system arrangement. And optimum power cannot be obtained due to no proper alignment of solar power.

## 3. Proposed Method

The main objective of this project is to get an optimum power output from the solar panels during dust is accumulated on it. Also, if there is any malfunctioning of the solar panels will be displayed on and we can also get information about whether the solar or battery connected for the loads. The system detects and alerts the user or the administrator when is fall below the pre- define conditions, and display on the GUI. A solar panel is used that keeps monitoring the sunlight. Here different parameters like voltage, current and temperature are displayed on the LCD by using IOT technology.

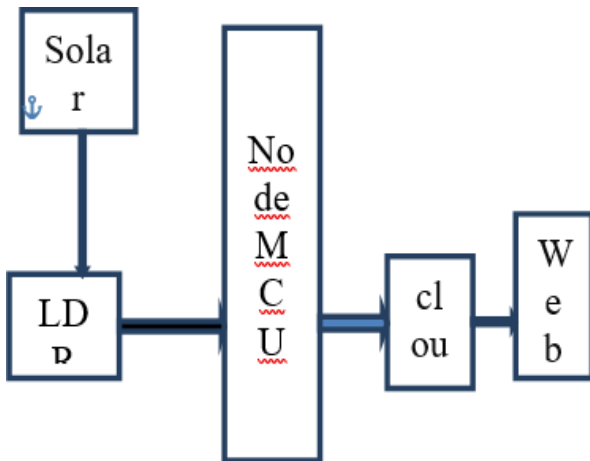

Fig. 4: Block diagram of proposed method

The above shown is the block diagram in figure 4 is the block diagram of the proposed method

#### 4. Hardware Implementation of the Proposed Method

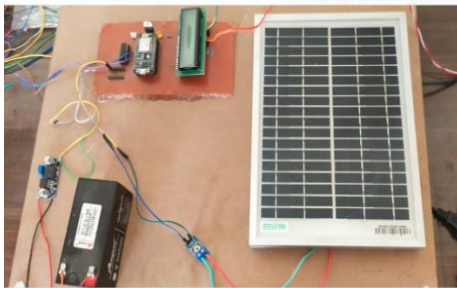

Fig. 5: Hardware implementation of the proposed method

The most conspicuous part of a residential solar power system is the solar panels. Thin-film semiconductor or crystalline silicon is used make the P V solar cell for many of the residential applications. These photovoltaic (PV) devices contain semiconductors that generate electricity directly from sunlight. The electrical devices are powered, or it is send to the grid when electrons are made free by solar energy in these materials. One of the most important aspects of getting your solar panels to produce electrical energy at optimum efficiency is keeping them in full and direct sunlight. DC voltage current is generated when the Photovoltaic solar panels are exposed directly to the sunlight. Solar panels generate the DC were the home appliance works on the AC power, so the output of the panels is given as input to the invertor. All the appliance works through the invertor. The invertor consists of a battery. The battery gets charges when the appliance is not in used and gets discharged when requires the supply. Solar monitoring systems will track the amount of electricity your solar panels have generated and contributed to the power grid.

For the sensing the light we have used a light dependent resistor is component varies the resistance with the light intensity that fall on it and can different a night and a day There are many potential ways of monitoring solar panels. There are high tech solutions which upload data continuously to a web portal which allows you to monitor your systems performance from anywhere in the world. In this proposed system we have an open source cloud[10] platform application think speak is used. Which retrieves and stores the data from the sensor or the things connected to the systems through internet that uses hypertext transfer protocol (HTTP) from the local network to the cloud. It updates all the data logs received from the sensors, tracking location applications, and the status application giving to the users and taken from the users. To use this the user has create an account which contains different channels for monitoring of different parameters in the system or in the monitoring the paraments in a remote device.

This cloud enables the administrator or the user to visualize the data in graphical representation. With internet-based monitoring, energy output data is transferred to a router, making it available through an online interface. The main advantage of systems like these is that your solar panel output information is readily available anywhere you can get an internet connection

The node MCU acts as a key processing element for the proposed system as shown in figure 4 and figure 5 which is developed by ESP8266 open source community of micro-controller on single board that can be programmed using the Arduino IDE having a RAM size of 128Kbytes and program storage capacity of 4 Mega Bytes. It can be powered by a USB cable, having a operating voltage of 3.3 to 5 volts and an in built Wi-Fi SoC Architecture. The figure 6 show that Node MCU

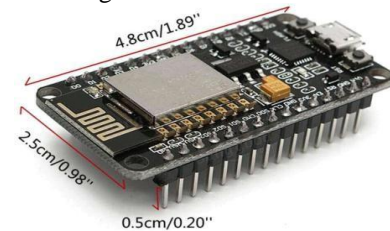

Fig. 6: Node MCU

- **Solar Panel**

The electricity generated by capturing the sun light is called as solar energy which is used for business and home purpose. The natural nuclear reactor is sun which releases the energy with tiny packets called photons. The atoms lose the electrons when the photons hit the solar cells. A solar panel is made of multiple panels that wired together, more electricity is generated by the more panels we deploy. Silicon like semiconductors are used to make the PV photovoltaic solar panels as shown in figure 7. Direct Current is generated by the solar panels. Most of the electrical appliance works on AC supply can AC can be

less expensive for transmit to long distances.

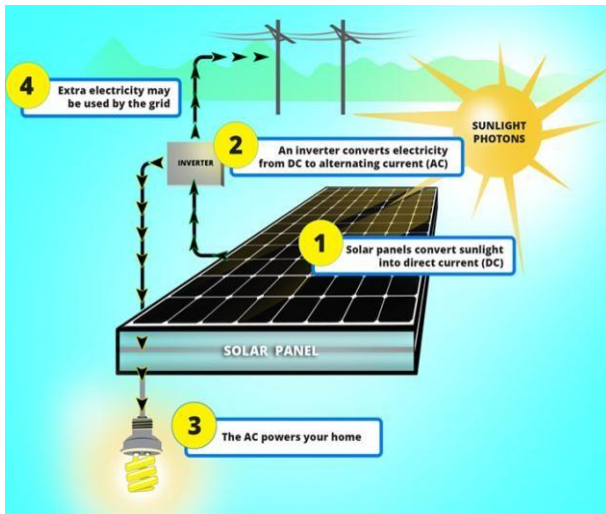

Fig. 7: Solar Energy Conversion

• **LDR**

Photo conductivity is the main working principle of a LDR or light dependent resistor. All the electrons in the semiconductor of the valance band excites when the light or photos fall on the resistor. When the light falls on the LDR resistance gets decreased and increase in the dark or called as dark resistance. Basing on the materials the LDR's are classified in to two types Intrinsic Photo Resistor and Extrinsic photo resistor.



• **XAMPP Cloud setup**

XAMPP is one of the widely used cross-platform web servers, which helps developers to create and test their programs on a local webserver. It was developed by the **Apache Friends**, and its native source code can be revised or modified by the audience. It consists of **Apache HTTP Server, MariaDB, and interpreter** for the different programming languages like PHP and Perl. It is available in 11 languages and supported by different platforms such as the IA-32 package of Windows & x64 package of macOS and Linux.

**5. Results & Conclusion**

In this project IoT based system is designed to get an optimum power output from the solar panels during dust is accumulated on it. And, a monitoring system is designed

for there is any malfunctioning of the solar panels will be displayed on and we can also get information about whether the solar or battery connected for the loads. It now displays these parameters as shown in figure 9 to the user using an effective GUI and alerts user when the output falls below specific limits. A solar panel is used that keeps monitoring the sunlight. Here different parameters like voltage, current and temperature are displayed on the LCD by using IOT technology. Now we are getting only information we can see it in cloud but in future we can control whole system through IoT which Distant is a way.

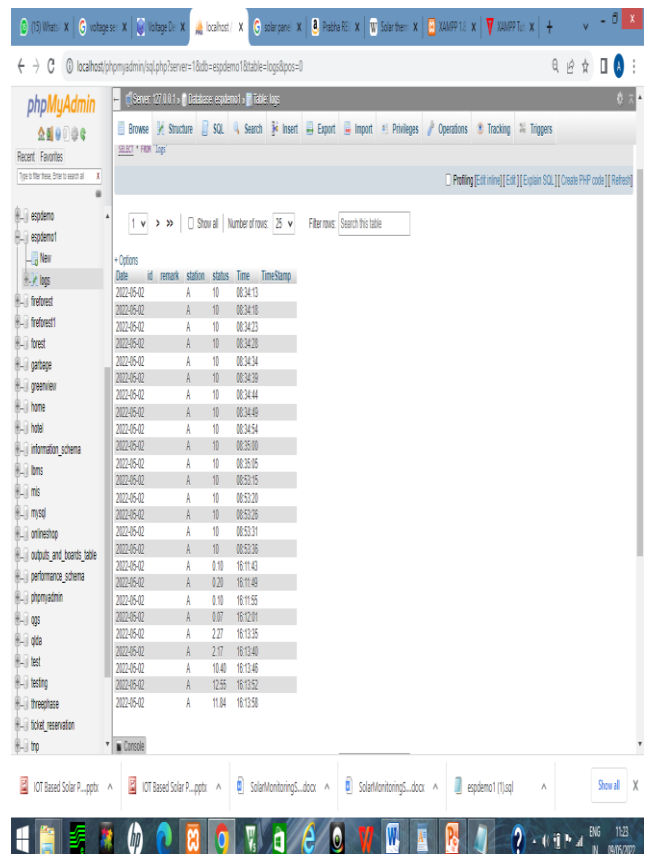
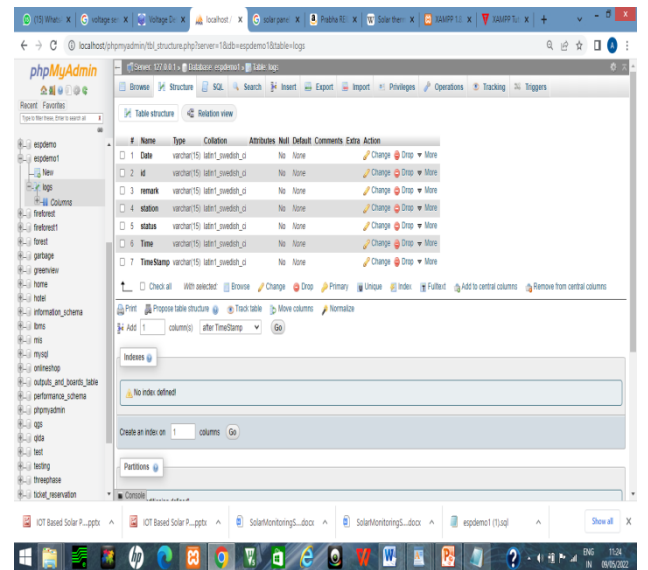

**Fig. 9:** LDR values transmitted from the working location to the cloud

### References

1. P. Gopi Krishna et. al. "Design and development of bi-directional smart IoT gateway with interoperability for heterogeneous devices" *International Journal of Engineering & Technology*, 7 (2.8) (2018) 109-114
2. Nordrum, Amy (18 August 2016). "Popular Internet of Things Forecast of 50 Billion Devices by 2020 Is Outdated". IEEE
3. M. Moon. (2009) Google Studies How Dirt Affects Solar Panel Efficiency. PC Magazine: Good Clean Tech. Available: [www.goodcleantech.com/2009/08/google\\_studies\\_how\\_dirt\\_affect.php](http://www.goodcleantech.com/2009/08/google_studies_how_dirt_affect.php)
4. M. C. Hottel and B. B. Woertz, "Performance of flat plate solar heat collectors," *ASME Trans.*, vol. 64, pp. 91-104, 1942.
5. Salim, F. Huraib, and N. Eugenio, "PV power-study of system options and optimization," in *Proceedings of the 8th European PV Solar Energy Conference*, Florence, Italy, 1988.
6. D. Goossens and E. V. Kerschaever, "Aeolian dust deposition on photovoltaic solar cells: the effects of wind velocity and airborne dust concentration on cell performance," *Solar Energy*, vol. 66, pp. 277-289, 1999. World
7. H. P. Garg, "Effect of dirt on transparent covers in flat-plate solar energy collectors," *Solar Energy*, vol. 15, pp. 299-302, 1973
8. P. Gopi Krishna et. al. "Design and development of smart energy meter for effective use of electricity in IoT applications" *International Journal of Engineering & Technology*, 7 (2.8) (2018) 115-119
9. P. Gopi Krishna et. al "Design and development of bi-directional IoT gateway using ZigBee and Wi-Fi technologies with MQTT protocol" *International Journal of Engineering & Technology*, 7 (2.8) (2018) 125-129
10. Agora Energiewende (2016), "Agorameter", website, [www.agora-energiende.de/en/topics/-agorathem-/Produkt/produkt/76/Agorameter/](http://www.agora-energiende.de/en/topics/-agorathem-/Produkt/produkt/76/Agorameter/) (accessed 23 May 2016).